

Converting Vehicles to Propane Autogas Part 2: Installing Underhood Components



Notice

Users of this material should consult the law of their individual jurisdiction for the codes, standards and legal requirements applicable to them. This material merely identifies methods that the reader may find useful in implementing applicable codes, standards and legal requirements. This material is not intended nor should it be construed to:

- (1) Set forth procedures which are the general custom or practice in the propane gas industry;*
- (2) Establish the legal standard of care owed by propane distributors to their customers;*
- (3) Prevent the reader from using different methods to implement applicable codes, standards or legal requirements.*

This material was designed to be used as a resource only to assist expert and experienced supervisors and managers in training personnel in their organizations and does not replace federal, state, or company safety rules. The user of this material is solely responsible for the method of implementation. The Propane Education and Research Council and the Alternative Energy Division of the Railroad Commission of Texas assume no liability for reliance on the contents of this training material.

Issuance of this material is not intended to nor should it be construed as an undertaking to perform services on behalf of any party either for their protection or for the protection of third parties.

The use of specific products or manufacturers' trademarks, names or descriptions is for reference and not intended as an endorsement. The manufacturers' names, their products and component descriptive words and terminologies are trademarked and registered by their respective owners.

All rights reserved. No part of this text may be reproduced, utilized, or transmitted in any form or by any means, electronic or mechanical, including photocopying, recording, or by any information storage and retrieval system, without permission in writing.

© 2012 Propane Education & Research Council

Caution



Always consult recognized standards (NFPA 58 or equivalent) and Original Equipment Manufacturer (OEM) installation publications when working with propane autogas systems. Pressure in fuel tanks and other system components may exceed 300 psig. Necessary safety precautions must be applied when installing, disconnecting or otherwise handling propane system components. Failure to apply adequate safety practices or failure to heed warnings while performing installation or repair procedures may result in serious personal injury or death to yourself or others.

Scope of This Course

This course, covering the installation of underhood fuel-system components, is Part 2 of a suite of courses on retrofitting, servicing and fueling highway vehicles that run on propane autogas¹. Part 1 covers the installation of fuel tanks and fuel lines. Part 3 covers the installation and operation of propane autogas dispensers.

The purpose of this course is not to teach the user how to convert a vehicle to propane, but to enable the user to compare the basic code requirements with other technologies and installation practices and use them as appropriate. At the time of this publication in the United States, the nationally recognized standards for vehicle conversions are found in National Fire Protection Association manual 58, *Liquefied Petroleum Gas Code* (NFPA 58). Some states have adopted additional or different code requirements. Users should check with the authority having jurisdiction in their areas to determine which requirements apply.

Additional references:

- CAN/CSA-B.149.5, *Canadian Installation Code for Propane Fuel Systems and Tanks on Highway Vehicles*
- EN67, the European standard for vehicles converted to LP gas

NOTE: Canadian and European conversion standards are referenced to demonstrate that other options are available and practiced worldwide. It is the installer's responsibility to determine the appropriate standard or practice to use for each application.

Manufacturers' installation instructions must be followed in all cases. Some manufacturers of autogas fuel systems may require installers to complete the manufacturer's own training course in order to be certified as an authorized installer. This course is not intended to substitute for any such manufacturer-required course.

¹ "Propane autogas" or "autogas" is the term used internationally to refer to propane used as an engine fuel to propel on-road vehicles.

Acknowledgments

The Propane Education and Research Council gratefully acknowledges the cooperation and contribution of the following individuals and organizations for providing personnel, equipment and technical assistance.

Franz Hofmann

Railroad Commission of Texas, Alternative Energy Division, P.O. Box 12967, Austin, Texas 78711, (512) 463-8501, franz.hofmann@rrc.state.tx.us

Steve Jaeger

Railroad Commission of Texas, Alternative Energy Division, P.O. Box 12967, Austin, Texas 78711, (512) 463-9202, steve.jaeger@rrc.state.tx.us

Dan Kelly

Railroad Commission of Texas, Alternative Energy Division, P.O. Box 12967, Austin, Texas 78711, (512) 463-7291, dan.kelly@rrc.state.tx.us

Gordon Frey

Frey Associates, 2295 Willingham Lane, Maryville, Tennessee 37803, (865) 233-0666, gfacsm@charter.net

Robert Myers

Boulder, Colorado, (303) 449-0764, remyers38@aol.com

Bill Platz

Delta Liquid Energy, 1960 Ramada Drive, Paso Robles, California 93446, (805) 239-0616, billp2@deltaliquidenergy.com

Gary Shepherd

Stanford LP Gas, 3611 North Eastman Road, Midland, Michigan 48642, (989) 835-4754, gashepherd@slpg.net

Bruce Swiecicki

National Propane Gas Association, 1899 L Street NW, Washington, D.C. 20036, (202) 466-7200, bswiecicki@npga.org

Michael Taylor

Heritage Propane, 500 Meijer Drive, Suite 200, Florence, Kentucky 41042, (859) 647-4044, Michael.Taylor@HeritagePropane.com

Calvin Thorn

CleanFuel USA, 116 Halmar Cove, Georgetown, Texas 78628-2331, calvin.thorn@cleanfuelusa.com

Stuart Weidie

Blossman Gas, P.O. Box 1870, Candler, North Carolina 28715, (828) 667-0437, seweidie@blossmangas.com

Credits

CleanFUEL USA..... Figure 68
IMPCO/BRC Figures 4, 12, 18, 20, 23, 24, 26, 27, 28, 31, 35
Roush CleanTech Figures 55, 58, 61, 62, 64

Unless otherwise noted, all other photos are by the author.

Scope of This Course	iii
Acknowledgments	iv
Credits	v
CHAPTER 1: Introduction	2
1.1 Fuel-System Types	2
1.2 Fuel-System Manufacturers	2
CHAPTER 2: Procedures Applicable to All Conversions	6
2.1 The Vehicle Interface	6
2.2 Electrical Connections	6
2.2.1 Types of Wiring Connections.....	8
2.2.2 Wiring Connectors	8
2.2.3 Installing Wiring Connections in the Field.....	9
2.2.4 Wire Soldering.....	11
2.2.5 Heat-Shrink Tubing.....	12
2.2.6 Wire Bundling	14
CHAPTER 3: Vapor Fuel-Injection Systems	16
3.1 Cooling-System Connections.....	16
3.1.1 Parallel and Series Connections.....	16
3.1.2 Cooling-System Hoses and Clamps.....	17
3.2 Locating and Mounting the Vaporizer	18
3.2.1 The Safety Box.....	20
3.3 Installing Vapor Fuel Injectors	20
3.3.1 Preparing the Intake Manifold	21
3.3.2 Installing Injector Nozzles	25
3.3.3 Mounting Injector Rails	28
3.3.4 Low-Pressure Fuel Hoses.....	29
3.3.5 Vapor Fuel Injectors in a Dedicated Application	30
3.3.6 Fuel Filters.....	30
3.3.7 Programming the Auxiliary Computer.....	32
CHAPTER 4: Liquid Propane Fuel-Injection Systems	36
4.1 Removing the Gasoline Fuel System	36
4.2 Liquid Injection Fuel Lines	37
4.3 Manufacturer-Specific Conversion Recommendations.....	37
4.3.1 Roush CleanTech	37
4.3.1.1 Conversion Without Cab Removal.....	38
4.3.1.2 Conversion With Cab Removal.....	40
4.3.2 CleanFuel USA LPI.....	47
4.4 Underhood Components of LPFI Systems	48
4.4.1 Flow-Control Solenoid / Fuel-Pressure Regulator	48

Table of Contents

4.4.2 Liquid Fuel Injectors	49
4.4.3 Wiring and Controls	50
4.4.4 LPFI Fuel Filters.....	55
4.4.5 LPFI Computer Calibration.....	56
CHAPTER 5: Quality Controls	58
5.1 Pre-Delivery Inspection	58
5.2 Final Performance Test Drive	59
5.3 Final Delivery Inspection Checklist	61
Appendix A: Vapor Pressure Index Chart.....	65
Appendix B: Material Safety Data Sheet.....	66
Appendix C: Glossary	74
Appendix D: Calculating Electrical Loads	81



LIQUID PROPANE INJECTION
ENGINE SYSTEMS:



Chapter One

Introduction

CHAPTER 1: INTRODUCTION

The quality and appearance of an underhood installation determine both a converted vehicle's performance and the customer's acceptance of the conversion. A high-quality underhood installation should reward the customer with optimum performance, durability, warranty, resale value and diagnostics.

1.1 Fuel-System Types

Current propane autogas fuel systems are available in either bi-fuel or dedicated (propane only) configurations. The systems are either the vapor fuel-injection type or the liquid fuel-injection type. System components are seldom interchangeable, because they are designed and optimized for one or the other of these technologies.

1.2 Fuel-System Manufacturers

The list below is not exhaustive. It is limited to manufacturers whose systems were certified by the U.S. Environmental Protection Agency and/or the California Air Resources Board and had achieved a significant installed base at the time of writing. EPA and CARB maintain lists of all currently certified systems online at

<http://epa.gov/oms/consumer/fuels/altfuels/altfuels.htm#4>

and

<http://www.arb.ca.gov/msprog/onroad/cert/cert.php>.



CleanFUEL USA LPI

The CleanFUEL USA dedicated liquid fuel-injection system includes all hardware required for the installation, including the fuel tank and fuel lines. No customer- or installer-modified components are permitted.

CFUSA has 50-state EPA and California ARB emissions certification on select platforms.



IMPCO/BRC Sequent

The IMPCO/BRC Sequent bifuel vapor fuel-injection system begins at the fuel lockoff and includes all underhood components. The selection and installation of the fuel tank and fuel lines, including routing, are the installer's responsibility.

The IMPCO/BRC Sequent system has 49-state EPA emissions certification.

Items provided in the installation package:

- Fuel tank, including multivalve;
- Fuel fill adapter, with filter and fuel line;
- Fuel rails, including fuel injectors;
- Fuel injector wiring harness;
- Fuel pressure regulator;
- Fuel supply hoses;
- Fuel control unit (also called the fuel pump module);
- Wiring harness;
- Reprogrammed vehicle computer.

NOTE: No customer or installer-modified components or adjustments are permitted, with the exception of performing the initial vaporizer outlet pressure adjustment as specified by the manufacturer for the specific EPA vehicle calibration.

Items provided in the installation package:

- Fuel inlet lockoff;
- Fuel inlet filter;
- Vaporizer and mounting bracket;
- Outlet hoses and clamps;
- Secondary fuel filter;
- Fuel rails and injectors;
- Fuel rail pressure and temperature sensors;
- Manifold absolute pressure (MAP) sensor;
- Fuel injector outlet hoses and clamps;
- Fuel injector hose nozzles;
- Wiring harness and switch;
- Fuel pump and fuel gauge emulators (if used), depending on the application;
- Supplemental fuel system computer.



Prins

The Prins vapor fuel-injection system begins at the fuel lockoff and includes all underhood components. The selection and installation of the fuel tank and fuel lines, including routing, are the installer's responsibility.

Prins is an equipment manufacturer and supplier. Through its North American affiliates, Prins has EPA emissions certification on select platforms in 49 states.



Roush CleanTech LPI

The Roush CleanTech dedicated liquid fuel-injection system provides all hardware required for the installation, including the fuel tank and fuel lines. No customer- or installer-modified components are permitted.

Roush CleanTech has EPA and California ARB emissions certification on selected platforms.

Items provided in the installation package:

- Fuel inlet lockoff;
- Fuel inlet filter;
- Vaporizer and mounting brackets;
- Secondary fuel filter;
- Fuel rails, including injectors;
- Fuel injector simulators/ translator modules;
- Fuel rail pressure and temperature sensors;
- Fuel injector hoses and clamps;
- Fuel hose intake manifold adapters;
- Wiring harness and switch;
- Supplemental fuel system computer.

NOTE: No customer or installer-modified components or adjustments are permitted, with the exception of performing the initial vaporizer outlet pressure adjustment as specified by the manufacturer for the specific EPA vehicle calibration.

Items provided in the installation package:

- Fuel tank, including multivalve;
- Fuel tank mounting kit, including mounts, sleeves, mount plates, vehicle modification templates, protective guards, and other related hardware;
- Fuel fill adapter, with filter and fuel line;
- Pressure relief valve vent hose assembly;
- Fuel rails, including fuel injectors;
- Fuel injector wiring harness;
- Fuel flow control solenoid;
- Stainless steel fuel lines, with attachment hardware;
- Fuel pump wiring harness, relay and fuse box;
- Reprogrammed vehicle computer.



Chapter Two

***Procedures Applicable
to All Conversions***

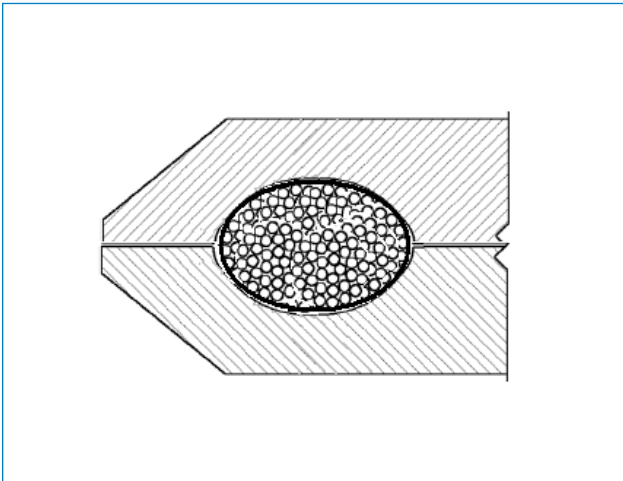

CHAPTER 2: PROCEDURES APPLICABLE TO ALL CONVERSIONS

2.1 The Vehicle Interface

When retrofitting a vehicle to operate on propane autogas, every effort must be made to maintain the integrity of the original vehicle. This principle should guide the installer when modifying not only the vehicle's body, but also its engine, cooling system and electrical system. All connections and integration of components to the vehicle should be performed at the original equipment manufacturer's (OEM) level of quality or better.

The completed conversion should appear as if it were an integral part of the OEM vehicle. Substituting lower-grade bolts or hoses for those provided by the OEM is not acceptable and may result in a loss of performance, weakening of a component or an unsafe vehicle.

Converting a vehicle to operate on propane rarely requires modifications to internal engine parts. Today's OEM vehicles are equipped with improved exhaust valves and valve seats. Cylinder-head upgrades may be available for vehicles in moderate to severe service. Some OEM vehicle suppliers have a gaseous fuel engine prep package that may be ordered prior to production.

Current liquid propane fuel-injection (LPFI) systems are designed for autogas-only operation. These systems typically require no modifications to the engine's intake manifold. Future bifuel systems will be installed like vapor fuel-injection systems, using new openings drilled in the intake manifold runners to receive injector nozzles. These bifuel systems will use the original vehicle's powertrain control module (PCM) without reprogramming. They will rely on a small supplemental module to control fuel-pump operation when switching back and forth from gasoline to propane.

2.2 Electrical Connections¹

Conversions typically require modifications to the vehicle's electrical system. The fuel-system manufacturer determines the extent of these modifications. Bifuel vapor injection systems typically require more wire-to-wire modifications than dedicated liquid fuel-injection systems. In addition, some autogas fuel systems are designed to fit more than one make or model of vehicle. This means not every wiring connection provided by the fuel-system manufacturer will be used in every vehicle application.

Whenever cutting into the vehicle's original wiring harness is required, the new wiring connections should be made in locations that provide adequate working access for future service. New or modified wiring must not interfere with the vehicle's throttle linkage, exhaust manifold or steering linkage. Wiring modifications should be made in the same place on similar vehicles, to ensure uniformity and aid in troubleshooting any electrical issue that may arise.

¹ NFPA 58 includes no standards on electrical system installations. This chapter describes installation procedures that are equal to or better than the procedures used by OEMs.



WARNING

Disconnect and protect both battery terminals when performing wiring modifications on any vehicle. Removing the battery is recommended.

Almost all vapor fuel-injection systems use an auxiliary PCM that intercepts the gasoline fuel-injector circuits and modifies the injector output signals to provide the proper air-fuel mixture. The auxiliary computer has a dedicated wiring harness and electrical connections for its memory and control functions.

Rolling Ground

Secure electrical connections are critical to a successful conversion. One of the most common faults in establishing a secure circuit is a “rolling ground.” This fault occurs when the vehicle’s original ground circuit loses its connection. The electrical system then tries to find the next most secure ground circuit, which may be the circuit installed for the autogas fuel system’s auxiliary computer.

Unless specifically requested or required by the fuel system manufacturer, do not connect the new ground circuit directly to the battery. If a primary ground problem develops, the vehicle may use the added ground wire as the vehicle chassis ground. This may result in hard-to-diagnose electrical faults, melted wiring, corrosion and/or failure of the secondary cable connection.

Do not pinch the ground and/or positive electrical terminal leads under a battery terminal lug or insert a sheet metal screw into the battery post. Instead:

- If at all possible, use the vehicle’s original computer ground or a good, solid engine ground. Do not connect the ground circuit directly to a single body or chassis ground location. The combined body ground circuit provided by the manufacturer is acceptable.
- If possible, use the positive terminal at the vehicle’s power-distribution junction box located away from the battery. Fuel-system manufacturers often require an unused master electrical terminal that remains energized at all times when the key is in a switched electrical power-supply position.
- All primary positive cable connections at the junction box that feed the secondary computer must be protected by a proper fuse.

Installer’s Tip

Fuse Load

To calculate the fuse load if not provided by the manufacturer, add the listed amperage ratings of all the electrical component loads on that circuit. If the amperage rating in a circuit is not known, contact the fuel-system manufacturer or supplier to obtain the amperage or wattage ratings for the component in question. Some technicians add 30 percent to this circuit load requirement to allow for momentary electrical surges.

See Appendix D for more information on electrical circuits.

2.2.1 Types of Wiring Connections

Wiring connections are of two types: the intercept splice and the tap splice (sometimes called a “tee” splice). See Figure 1.

An **intercept** splice will open a circuit, modify the circuit’s voltage or resistance, or add an additional component to an existing circuit. Examples of wiring intercepts are the circuits that control the fuel injectors, fuel pump and fuel gauge.

A **tap** splice reads a circuit’s voltage or signal. An example of a wiring tap might be a location where the supplemental computer module reads the voltage of the mass air-flow sensor, throttle position sensor or oxygen sensor.

In both types of connections, the completed wire joint should be mechanically and electrically secure and weather-resistant.

When cutting into the vehicle’s electrical wiring, the cut should be at least three inches away from any connector. Although not required by code or standard, locating the splice away from a connector should allow access for technicians performing future service or repairs.

Immediately after performing a wire splice, the appropriate bare wire insulation should be installed. The insulation material may be heat-shrink tubing, properly rated electrical tape, or liquid insulating wire joint sealant. The step-by-step procedure below illustrates a properly sealed wire connection using heat-shrink tubing.

2.2.2 Wiring Connectors

A wire connector or wire-splice connection should provide two critical functions: a secure mechanical bond and a secure electrical bond.

Under no circumstances should bare wires be twisted together in a permanent connection without crimping or soldering. Bare-wire connections using wire nuts, a taped joint, paint-on sealers or wire piercing and slicing are not recommended.

Although a soldered connection is the most secure, a quality crimped connection is acceptable. Generic crimp connectors may not provide a permanent and secure connection if the technician does not install them properly or consistently.

OEMs do not solder every wire connection when assembling wiring harnesses and wire terminals. Most OEMs use crimp connections. Aftermarket installers typically do not have access to production wire-terminal assembly machinery that provides precise, consistent crimping. Nevertheless, a skilled aftermarket installer using the proper connectors, tools and techniques can achieve OEM-quality crimps.

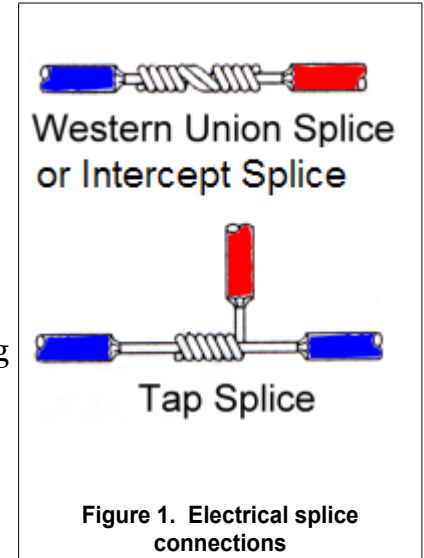

2.2.3 Installing Wiring Connections in the Field

Figure 2 shows a wire “ring” terminal that secures both the wire and its insulation. Additional electrical security may be provided by soldering the wire crimp.

The specialized ring terminal has two crimp areas:

This crimp secures the wire insulation.

This crimp secures the wire.

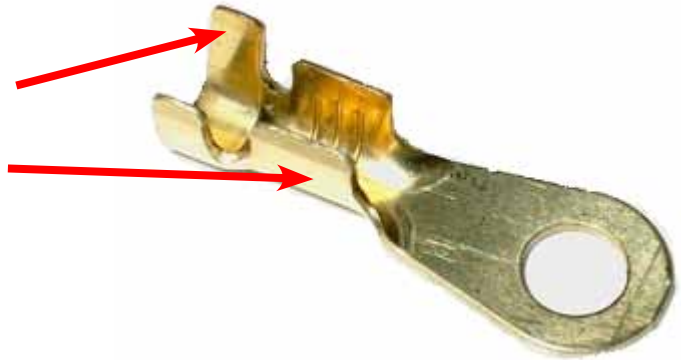

Figure 2. Ring terminal

Some crimp connectors squeeze or crush a metal band around two or more wires. Other crimp connectors secure the wires with a specific crimp that provides additional electrical and mechanical bonds.

Figure 3 shows a crush connector.

The crush-type connector is the one most commonly used, with or without insulation. If the terminal is not insulated, care must be taken to prevent accidental contact with bare metal.

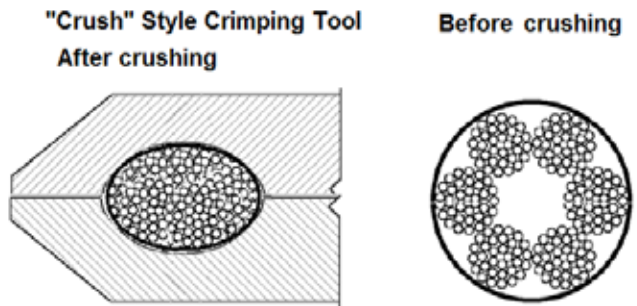

Figure 3. Crush connector

In a U-type crimp connector, the wires are laid in a U-shaped trough and the two ends are folded over into a heart-shaped connector. The connection may then be soldered.

In a barrel-type crimp connector, the wires are inserted into a metal tube or sleeve, which is then crimped. This connection may also be soldered.

Both U-type and barrel-type crimp connectors are similar to those used by OEMs.

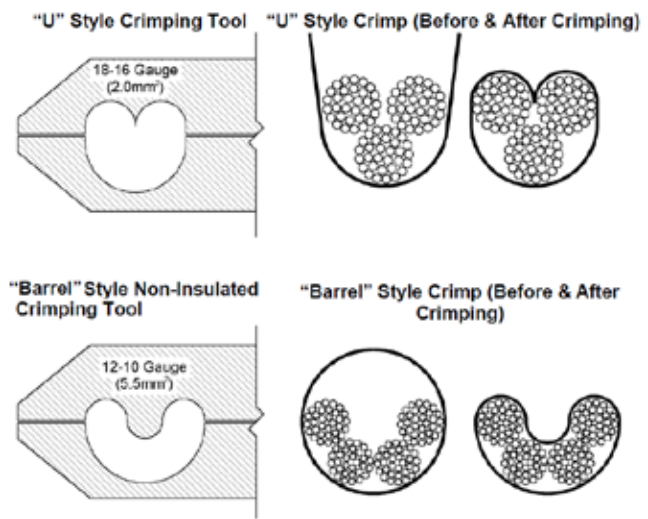

Figure 4. U-type and barrel-type crimp connectors

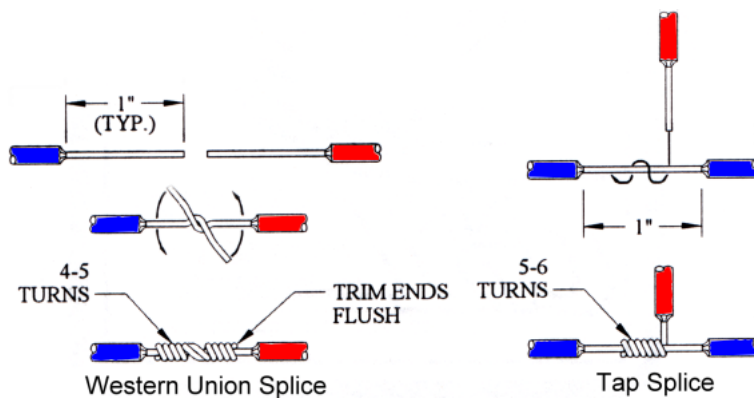

Figure 5 . Intercept and tap connections

Figure 5 shows the proper method of splicing wire connections.

The insulation should be carefully stripped back at least $\frac{1}{2}$ " to 1" using wire-stripping tools that do not cut into the wire. If wire strands are cut during stripping, the wire must be re-cut and re-stripped.

NOTE: When the wire insulation is stripped away, bare, clean wires should be visible. If the ends of the wires are not bright, clean copper, or if they show any signs of tarnish or oxidation, cut the wire insulation back until clean copper wire is visible.

NOTE: If the wire has been exposed to any oil or lubricant, a secure soldered connection will be difficult to achieve.

Immediately prior to joining the bare wire terminations, slip sections of heat-shrink tubing onto the wire. Make sure that the tubing is slipped away from the soldering process to prevent premature shrinking.



Figure 6. Loose section of heat-shrink tubing prior to shrinking and soldering

Procedures Applicable to All Conversions

NOTE: When performing a tee wiring connection, the wire may be de-pinned from the closest wire terminal in order to slip heat-shrink tubing over the completed joint. Reassemble the de-pinned connection. Follow the vehicle manufacturer's recommendations when de-pinning and reconnecting any OEM wire plugs or connectors.

If de-pinning is not possible, execute an intercept splice by cutting the OEM wire and adding in the third tee wire parallel to one of the wire ends. Remember that the new wire splice connection will be approximately one inch shorter after the wire ends are spliced.

Cross the two wires at approximately the halfway point and twist them firmly together.



Figure 7. Twisting the wire connections together prior to soldering

No loose strands or sharp wire edges should protrude from the connection. Loose strands or sharp edges may penetrate the heat-shrink tubing and cause an electrical short or malfunction.



Figure 8. Mechanical connection prior to soldering

2.2.4 Wire Soldering

Many electrical circuits in a propane autogas conversion carry low voltages. Good electrical conductivity is critical in these circuits, and good-quality solder connections are essential to achieve optimum performance.

All electrical connections should be made using low-lead, electronics-grade 0.7mm to 1.0mm rosin-core solder (63/37 percent tin-to-lead ratio). Never use acid-core solder. Acid will corrode any electrical component and lead to component failure.

Apply heat to the underside of the wire connection. Apply solder to the top of the connection and allow the solder to flow into the wire. Heat the joint enough to allow the solder to flow, but not enough to melt the wire insulation.

Overheating the joint may allow the solder to wick up inside the wire and under the insulation. If this happens, the joint may be too stiff and could eventually break.



Figure 9. Proper method of heating a wire connection during soldering

Solder should fully penetrate the wiring joint to ensure a solid mechanical and electrical connection. Excess solder droplets should be removed by tapping the solder joint while still molten. The solder connection should appear to be “painted on,” as opposed to “puttied on.” Individual wire strands should be just barely visible.



Figure 10. Properly soldered wire connection

If the completed solder joint appears frosty or granulated, the joint was either not properly cleaned or not heated enough to allow the solder to flow through the joint. A clumped or lumpy solder joint may indicate that the wiring was disturbed before the solder cooled. This is called a “cold solder joint.” A cold solder joint will not have the same electrical conductivity as a properly formed solder joint and will eventually fail.



CAUTION

All components must withstand high underhood temperatures. Plastic convoluted wire loom or other products used to secure wire looms and harnesses should be resistant to heat.

Plastic wire loom may ignite if it comes into contact with the exhaust system.

When the solder joint is complete, the previously installed heat-shrink tubing should be slipped over the joint and activated with a heat gun. Using a match or lighter may concentrate too much heat in one location and may cause an uneven shrink and seal or melt the tubing. A heat gun with a semi-circular deflector provides consistent heating and shrinking (see Figure 12).

If the wire joint is in danger of being pinched or exposed to abrasion, two pieces of heat-shrink tubing may be slipped over the joint. Heat and shrink the first section; then when it fully cools, slip the second piece over the first and re-apply the heat source. A larger-diameter heat-shrink tubing may be necessary for the second layer.

2.2.5 Heat-Shrink Tubing

Heat-shrink tubing effectively seals bare wires against moisture, abrasion and unintentional electrical contact. Heat-shrink tubing is manufactured in a variety of colors, sizes, quality, wall thickness, shrink ratios and sealing ability. To ensure a secure electrical connection, the installer must select the proper grade of tubing and apply it correctly.

Size

Heat-shrink tubing should no smaller than 1.5 to 2.0 times the diameter of the combined wire joint before shrinking. Tubing must be properly sized so that it can be slid over the soldered connection before heat is applied.

Shrink Ratio

When heat-shrink tubing is properly heated, its diameter shrinks. The shrink ratio is usually printed on the tubing. Tubing with a 2:1 shrink ratio is the most common, but shrink ratios of up to 4:1 are available. When selecting tubing, keep in mind that the greater the shrink ratio, the greater the possibility of wrinkles or deformations in the resulting connection. Tubing with a 2:1 to 3:1 shrink ratio is ideal for automotive applications.

Wall Thickness

Heat-shrink tubing comes in three grades: thin, medium and heavy wall. Thin-wall tubing is approximately the thickness of electrical tape. Thin-wall tubing can tear easily during shrinkage and may not provide sufficient protection over an irregularly shaped electrical connection. Heavy-wall tubing provides sufficient protection, but adds bulk during final packaging. Medium-wall heat shrink tubing is more than adequate for most applications and provides effective packaging and security of the wiring joint.

Sealing Ability

Some heat-shrink tubing is designated “double wall” or “melt wall.” The outer wall is conventional, medium-thickness shrink tubing. The inner wall is coated with a glue or resin adhesive. When heat-activated, this adhesive coating flows around the joint and appears at the ends of the tubing, indicating proper adhesion. Double-wall or melt-wall tubing is recommended to weather-seal the soldered joint and provide additional mechanical strength.

Installation

Select a length of heat-shrink tubing about twice as long as the finished wire splice, to provide coverage on both ends of the wire insulation as well as the wire joint.

Slip the appropriate length of tubing over the wire **BEFORE** performing the wire connection and soldering.

Solder the connection. When the newly soldered joint has cooled to the touch, slip the shrink tubing over the joint. Ensure that an equal length of wire insulation is covered at each end.



Figure 11. Heat-shrink tubing prior to shrinking

Apply uniform heat until the shrink tubing seals fully against the wire insulation and the sealant resin begins to protrude from the wire.

If the shrink tubing shows signs of bubbling or burning, or if the tubing ends appear to be irregular in sealing, remove the heat source immediately. The finished joint should have a smooth, fully shrunken appearance.

Figure 12 shows a type of tool that provides uniform heat around the shrink tubing for a consistent seal and shrinkage.

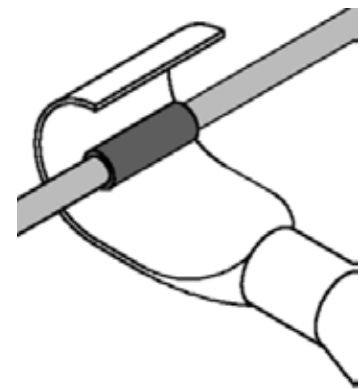

Figure 12. Heat gun attachment

Figure 13 shows properly set heat-shrink tubing. Note the sealant protruding from the tubing ends.

The wire joint shown in Figure 13 is mechanically secure and environmentally sound. It will not come apart or allow the joint to be contaminated by water or oil.



Figure 13. Properly set heat-shrink tubing

2.2.6 Wire Bundling

Avoid bundling all the wiring connections in the same location. Where possible, stagger the wiring connections to avoid bulk and to keep the connections from rubbing together and possibly electrically cross-connecting. The wiring harness should not be stretched across any engine component or block service access. If possible, route the wiring in the same location as the original wiring harness, taking full advantage of the original mounting locations and protection from water or road debris.

When the wiring installation is complete, all wiring should be covered with heat-rated convoluted wire loom, expanded fiberglass wire braid, or neatly taped using a non-UV-reactive and heat-rated black electrical tape. Avoid using off-color wire loom or electrical tape. The final product should appear identical to the original vehicle installation.

Secure the new wiring harness to the original wiring harness with heat- and UV-rated wire, zip ties or other suitable means.



Chapter Three

Vapor Fuel-Injection Systems



CHAPTER 3: VAPOR FUEL-INJECTION SYSTEMS

This chapter covers underhood installation procedures specific to vapor fuel-injection systems. These procedures include connecting to the OEM vehicle's cooling system; locating and mounting the vaporizer; installing vapor fuel injectors, nozzles and fuel rails; and programming the fuel-system manufacturer's auxiliary computer.

Underhood installation procedures specific to liquid fuel-injection systems are covered in Chapter 4.

3.1 Cooling-System Connections

Vapor fuel-injection systems require an interface with the vehicle's cooling system. Liquid fuel-injection systems do not.

In a vapor fuel-injection system, a vaporizer (sometimes called a converter) converts liquid propane to vapor before injecting it into the intake manifold. The vaporizer draws the heat needed to perform this function from the engine's cooling system.

3.1.1 Parallel and Series Connections

The vaporizer-cooling system interface may be plumbed either in series or in parallel. Both methods are acceptable.

- **Series connection.** Figure 14 shows a series connection accomplished via one heater core hose. Generally the "hot" or supply hose is used, although most installations use whichever heater hose is closest to the vaporizer. This method places the propane vaporizer in a series circuit with the heater core. All engine coolant that passes through the heater core also passes through the vaporizer.
- **Parallel connection.** Figure 15 shows a parallel connection accomplished via the two heater hoses. The installer places directional water Y's in each hose. This routes the coolant to and from the vaporizer in a parallel circuit with the heater core and may prevent overheating of the vaporizer. When connecting hoses to the Y fittings, the installer should pay close attention to the direction of coolant flow.

No code requirements dictate which component is routed first, or that the coolant be routed in a particular direction. Some installation locations allow for the vaporizer to be plumbed first; others allow for the heater to be plumbed first. All vehicles converted in an individual fleet should be plumbed identically.



CAUTION

Some vehicles have an active heater control valve that diverts or stops the flow of coolant through the heater core when the temperature control is switched to “cold.” When that happens, coolant will also stop flowing through the vaporizer, resulting in a frozen vaporizer.

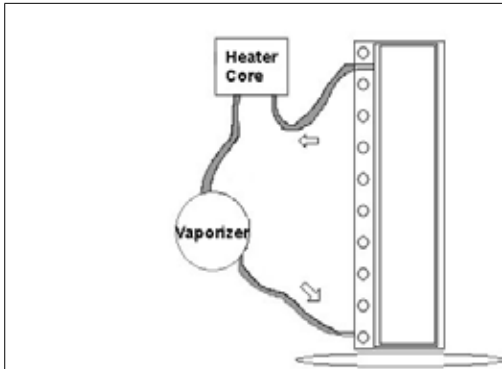

Figure 14. Series method of installing a vaporizer heater hose

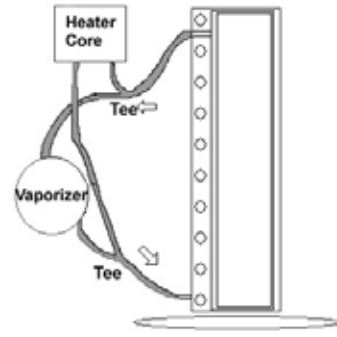

Figure 15. Parallel method of installing a vaporizer heater hose

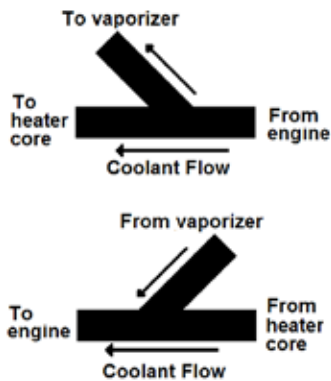

Figure 16. Heater hose tee or Y connectors.

The top image in Figure 16 shows a tee or Y connector spliced into the heater core hose on the warm or supply side. The coolant flow will tend to feed the branch connecting to the vaporizer.

The lower image shows the connector spliced into the heater core return hose at the return from the vaporizer.

If the heater hose is in a tight bind, the branch may be connected to the heater hose with the vaporizer feeding the other branch. Verify the flow direction before tightening hose clamps.

3.1.2 Cooling-System Hoses and Clamps

Verify that the additional cooling-system hoses are of OEM quality or better, that the hoses' colors match (for esthetic appearance), and that any connector hose clamps are oriented so as to prevent abrasion or cutting by the clamp strap. It may be necessary or desirable to use pre-formed hoses to avoid crimping or overstressing the hose in tight bends. Some fuel-system manufacturers provide replacement hoses, clamps and connectors with the proper cutting locations for consistent installations.

- **Clamp size.** Install hose clamps as recommended by the manufacturer. Avoid over-tightening. Use clamps that are sized appropriately for the hose (#10 clamp for 5/8" hose, #12 clamp for 3/4" hose). An oversize hose clamp will not tighten concentrically, resulting in voids in the hose sealing area that can lead to leaks, buckling of the hose and excessive hose-clamp protrusion.

- **Clamp position.** Hose clamps should be positioned to allow future access. Hose clamp ends are sharp, and they should be positioned where they cannot cut against any other hoses or impede future maintenance on the fuel system or the engine.
- **Hose size.** Never install oversize hose on a smaller fitting, *e.g.*, a 3/4" hose on a 5/8" fitting, or an undersize hose over a larger fitting, *e.g.*, a 5/8" hose over a 3/4" fitting. The hose connection will be degraded, significantly increasing the likelihood of a leak.
- **Protection.** Whenever the hose is located near metal edges or vibrating parts, additional abrasion protection is strongly recommended. Heater hoses may be covered with 3/4" wire loom for additional protection as well as a neat, professional appearance. Alternatively, a section of split heater hose may be slipped over the installed heater hose and secured with a zip tie.
- **Final steps.** Refill the vehicle's cooling system with the appropriate mixture of coolant and distilled water. Do not mix differently formulated coolants, *e.g.*, propylene glycol and ethylene glycol. Purge the cooling system as required by the vehicle manufacturer. Verify the coolant level when the vehicle is restarted and allowed to reach operating temperature.

3.2 Locating and Mounting the Vaporizer

The fuel-system manufacturer may specify the location and orientation of the vaporizer or provide vehicle-specific mounting brackets. In these cases, the installer must follow the manufacturer's instructions. The vaporizer may be mounted on the engine if no other locations are available in the engine compartment.

Different makes or models of vehicles may have different vaporizer locations. The location may be specified by the fuel-system manufacturer and must comply with the EPA certificate of conformity.

Figure 17 shows the vaporizer location for an IMPCO/BRC Sequent system on a 2008 or 2009 Ford F-150. The vaporizer is tightly mounted below the OEM PCM and behind the wiring-harness connectors.

The vaporizer is mounted in other locations on later year F-150s. Do not modify the manufacturer's supplied brackets except as specified by the manufacturer.



Figure 17. IMPCO Sequent vaporizer location on a 2008 or 2009 Ford F-150

On a 2010 Ford F-150, the IMPCO/BRC Sequent vaporizer is rotated 90° and placed in front of the vehicle's original PCM.

NOTE: This vaporizer mounting location is specified by the conversion system manufacturer. The blue loom and hose coverings shown in Figure 18 are provided for demonstration purposes.



Figure 18. IMPCO Sequent vaporizer location on a 2010 Ford F-150

Figure 19 shows a Prins vaporizer mounted directly on the engine due to space constraints.

When a component is mounted directly on the engine, the installer should ensure adequate hose clearance. Wherever possible, triangulate the vaporizer brackets to isolate the vaporizer from engine vibration.

NOTE: This installer has chosen to use a U.S.-manufactured fuel lockoff-filter instead of the one provided by the manufacturer. The fuel lockoff is not an emission-control device. Substituting a different unit does not void the emissions certification.



Figure 19. Vaporizer mounted directly on the engine

Vaporizers must be securely mounted, with sufficient slack to allow engine and body movement without damaging the hose that conveys propane vapor to the injectors. Most vaporizers mount vertically, to keep any accumulation of partially vaporized fuel from impeding operation.¹ The fuel-system manufacturer may recommend alternative installation locations or positions.

¹ Some authorities having jurisdiction may either require or prohibit certain vaporizer mounting locations. Vaporizers should be mounted as recommended by the fuel-system manufacturer, using brackets engineered for the application when provided.

Where no vaporizer location is specified, installers should try to mount the vaporizer at or below the level of the coolant fluid in the radiator. This placement prevents air bubbles from collecting in the vaporizer and reducing its ability to transfer heat efficiently.

Unless specified by the manufacturer, do not mount the vaporizer near any suspension component.

Positioning the vaporizer in a non-protected location or orientation is not recommended and may be prohibited in certain jurisdictions. Avoid mounting a vaporizer:

- In front of the radiator core support, where it may be exposed to crash or collision damage; or
- Under the body or below the chassis where it may be exposed to underbody impacts. The vaporizer should never be mounted or installed where it becomes the lowest part of the vehicle and is subject to damage from road debris, speed bumps, parking-lot wheel stops or street curbs.

Since the vaporizer is frequently combined with a fuel lockoff, fuel may leak during a collision if the lockoff is displaced from the vaporizer before the tank-mounted excess flow valve activates. To minimize the possibility of leakage during a collision, the installer may consider providing an inertia switch wired in series with the fuel lockoffs. The inertia switch will immediately stop the flow of fuel before the excess flow valve activates.

3.2.1 The Safety Box

Vehicle OEMs use the term “safety box” to refer to the engine-compartment area bounded at the rear by the firewall or bulkhead, at the front by the radiator core support, and by the left and right fender panels. The safety box is considered to be a secure area that protects steering, anti-lock brake systems, radiator and other critical components.

Protection against impacts is of paramount importance when locating a vaporizer or fuel lockoff. The most protective part of the safety box is the area near the power brake booster and the same location on the opposite side, near the heater and air-conditioning cores. Accordingly, the preferred location for mounting the vaporizer is on the firewall/bulkhead, as close to the engine as possible. This location takes advantage of the protection afforded by the engine’s mass in the event of a front-end collision.

Alternative locations are directly over the front wheel centerline, allowing for the wheels to provide some protection. While still within the safety box, locations adjacent to the radiator support or directly behind the headlamps offer less protection.

3.3 Installing Vapor Fuel Injectors

Most vapor fuel-injection systems are bifuel, meaning that the gasoline fuel system is retained intact as a backup to the propane autogas system. These systems typically require modifications to the engine’s intake manifold.

3.3.1 Preparing the Intake Manifold

In a vapor fuel-injection system, propane vapor is introduced into the engine through new injector nozzle openings drilled or machined into the intake manifold runners at specified locations adjacent to or just above the gasoline fuel injectors. The fuel-system OEM may provide a template or specify the locations of the injector nozzles.

Figure 20 shows an intake manifold for which the fuel-system manufacturer provides a paper template identifying the locations of the injector nozzles. The template specifies the exact drill locations and should be followed exactly.

If indicated in the system's EPA or CARB certification, the exact injector nozzle drilling locations must be followed to comply with the certification.



Figure 20. Intake manifold

Composite or plastic intake manifolds may be drilled in place on the vehicle if certain precautions are taken.

- Avoid operating drills and drill bits at high speeds that may burn or melt the manifold. High-speed drills will also fling drilled material into the intake manifold or around the engine compartment.
- A slow and steady variable-speed, reversible drill is preferred, to prevent overheating of the drill bit and the drilled material.



CAUTION

Suitable personal protective equipment should be worn whenever air or electric tools are used.

Aluminum intake manifolds should be removed from the vehicle for machining, to keep drilled aluminum shavings from entering the engine and causing significant damage.

As with composite intake manifolds, avoid high-speed drill bits when drilling aluminum. High drill speeds fling drilled material into the intake manifold or around the engine compartment. Use a good sharp drill bit and a slow, steady variable-speed reversible drill. A shop vacuum should be available to remove shavings and debris from the manifold before, during and after drilling.

Installer's Tip

Follow recommended shop procedures when removing the intake manifold, including disconnecting the battery, draining the coolant, and de-pressurizing the gasoline fuel rail. Procedures to perform these operations are published in OEM journals and other trade publications.

Installer's Tip

To keep drilled shavings from falling into the intake manifold, a regulated air supply at about 15 psig may be fed into the manifold through a PCV hose or the power brake booster hose. Air will be forced out of the hole as it is being drilled, helping to dislodge shavings. Safety glasses should be worn to prevent eye injury due to drilling debris.

Mark the location for the new injector nozzle. Then, using a slow-speed reversible drill, carefully drill through the intake manifold runner only. An extension and quick coupling helps reach difficult-to-access locations.

The drill angle is typically 90° to the intake runner air flow. Injecting fuel at right angles to the air flow helps induce turbulence that helps mix the air and fuel.

Combination drill and tap bits are very helpful. Figure 21 shows the installer using a 6mm x 1.0 combi-bit in a small hand-held drill.



Figure 21. Drilling the manifold runner with a combination drill and tap bit

Installer's Tip

Some tool vendors' catalogs or aircraft-tool salvage stores may supply unique angle or 90° drills that help drill manifolds in tight locations.

Installer's Tip

To keep from dropping the combi-bit in the manifold valley or losing it in the engine compartment, dedicate one handheld drill and combi-bit to manifold work and install a piece of heavy-wall heat-shrink tubing over the chuck and bit.

The 6mm x 1.0 combi-bit (also called a “drill-tap” or “D-tap”) shown in Figure 22 is the most common size used in vapor-injection conversions. This drill bit will cut a properly sized hole and threads all in one pass. Using an easily controllable reversible drill is mandatory. Many technicians prefer to use a small handheld rechargeable drill, because it is easy to control and can fit in tight spaces.



Figure 22. Combination drill and tap bit

Some intake manifolds require unique drilling procedures, such as the 2010 GM 6.0L shown in Figure 23.

For this application, the drill location for the injector nozzles is directly over the intake port and just above the gasoline fuel injector. The precise location is critical for compliance with the emissions certification. The black plastic runner to either side of the nozzle hole feeds the intake port on the opposite side of the engine.



Figure 23. Drill locations for 2010 GM 6.0L engine

Figure 24 illustrates the use of a drill-tap in a location directly over the intake port.



Figure 24. Drilling injector-nozzle holes for a 2010 GM 6.0L conversion

In Figure 25, the yellow circles show the drilled and tapped nozzle ports into the intake manifold. Some fuel-system manufacturers dictate the exact location for the injector nozzles. Others leave the decision to the installer. The drilled locations should be consistent.

All injector nozzle locations should be uniform in their relationship to the original injector. The gasoline injectors may be rotated slightly for access when drilling the nozzle port. If the gasoline injectors are rotated for access, they should be inspected for leaks when the vehicle is restarted.



Figure 25. Drilled and tapped nozzle ports

Figure 26 shows an intake manifold that is being drilled to receive the injector nozzles.

The 90° reversible air drill and drill-tap shown allow drilling in the tight confines typical of an underhood installation.



Figure 26. 90° reversible air drill and drill-tap

A hand-held ratchet wrench and drill-tap may be used if access to an intake port location is difficult.



Figure 27. Hand-held ratchet wrench and drill-tap

3.3.2 Installing Injector Nozzles

Figure 28 shows the injector nozzles installed in the drilled and tapped holes. Be careful not to over-torque nozzles installed in a composite intake manifold. The recommended torque is hand-tight plus 1/4 turn.

On some fuel systems, additional fittings may be installed for the MAP sensor and vaporizer pressure reference port.

A drop of thread-lock sealant on the nozzle is recommended for additional security.



Figure 28. Injector nozzles installed in drilled and tapped locations

Installer's Tip

For installation in tight spaces, a tee-handle hex wrench may be inserted through the hose and into the inside of the nozzle for use as an installation tool. The nozzle in Figure 29 has an internal hex profile that fits the hex wrench.



Figure 29. Nozzle installation using hex wrench inserted through hose

The manifold spud nozzle shown in Figure 30 has been fastened to the injector hose with an Oetiker clamp. Thread-locking and sealing compound has been placed on the threads.

The purpose of the clamp is to keep the hose fastened to the injector nozzle. Follow the fuel system manufacturer's recommendations on the proper method of securing this clamp.

Remember that this nozzle introduces propane into the intake manifold. The fuel injector, upstream from the nozzle, controls the fuel delivery rate.

The nozzle and hose are exposed to manifold vacuum. Thus, propane will never leak from this hose unless it is dislodged.



Figure 30. Oetiker clamp

Some manufacturers use a flared coupling on the hose end, as shown in Figure 31. One end connects to the manifold injector nozzle. The other end connects to the fuel injector outlet.

This manufacturer's injector nozzle fitting introduces propane in the middle of the incoming air stream to aid in air and fuel mixing.



Figure 31. IMPCO injector hose end assembly

Figure 32 shows the complete driver's side installation of the fuel nozzles and transfer hoses.

The next step is to install the fuel-injector rails.

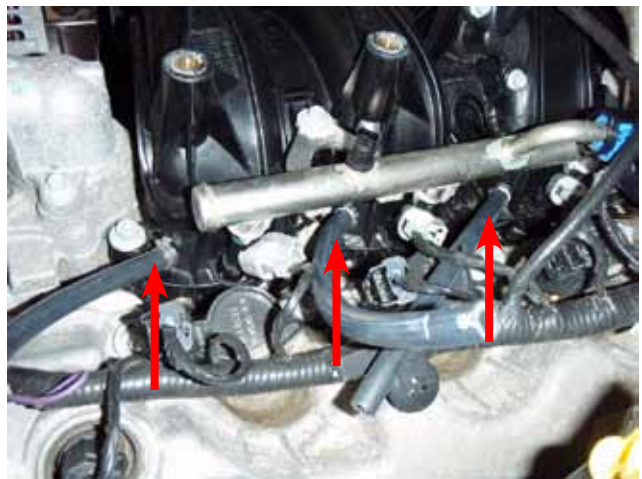

Figure 32. Completed hose and nozzle installation

Installer's Tip

When drilling holes into the intake manifold for the injector nozzles, many technicians apply grease to the drill tap to trap the shavings. The manifold must be oil- and grease-free after drilling, because any grease or oil left in the hole will keep thread-lock sealing compound from adhering to the manifold.

De-grease the drilled opening using a suitable chemical cleaner. Air-dry and apply the thread-lock sealing compound to the injector nozzle. Then carefully tighten to the recommended specifications.

3.3.3 Mounting Injector Rails

All vapor fuel-injection systems provide fuel injectors that are mounted in blocks or rails. These rails may be made from fiber-reinforced composite or aluminum. The fuel-injector rails are supported by brackets, which may be provided by the fuel-system manufacturer or may need to be fabricated by the installer.

Figure 33 shows a typical injector rail with bottom-feed injectors.



Figure 33. Typical fuel-injector rail

Some injector rails have additional components such as temperature thermistors and combined temperature and pressure sensors.

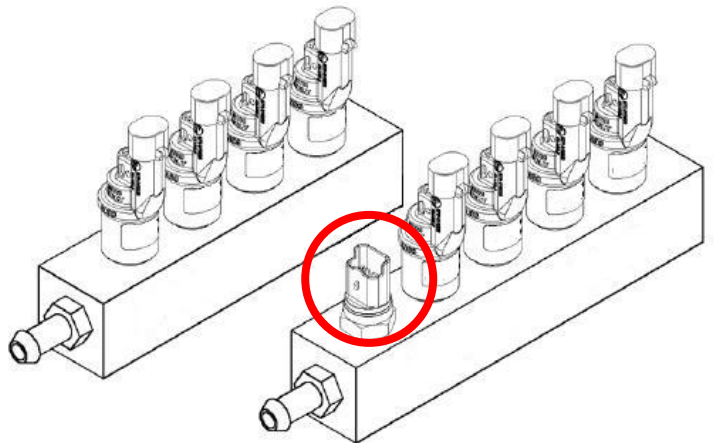

Figure 34. Additional component mounted on fuel-injector rail

Each engine cylinder will receive one injector. Depending on the underhood configuration and access to existing components, injectors may be mounted on a single rail, on two rails transversely, or in clusters of two or three injectors.

An injector rail should never be mounted on a body panel or near any high-tension electrical connection such as the starter, battery, alternator, or main junction panel. An injector or injector wire installed close to a high-tension electrical lead could either trigger or be triggered by electrical induction from an adjacent circuit.

If an injector rail is mounted directly to a body panel, the body panel will amplify the injector solenoid mechanical noise to an objectionable degree. Always follow any manufacturer's instructions provided when locating and mounting injector rails.

Injector rails should be mounted as close as possible to the intake manifold, to keep the fuel-transfer hoses as short as possible. These hoses are exposed to manifold vacuum. Longer hoses take longer to refill than shorter hoses. If the hoses are too long, the fuel-control system will have to overfill the hose to ensure that enough fuel reaches the cylinder at the proper time. This overfilling will alter the fuel-delivery calculations and can lead to erratic idling and low-speed engine emissions faults.

3.3.4 Low-Pressure Fuel Hoses

Fuel moves from the vaporizer to the fuel rails through low-pressure hoses, at about 25 to 35 psig. Follow the fuel system manufacturer's recommendations on fuel-hose routing, length and orientation.

Most fuel-system manufacturers use Oetiker hose clamps to retain low-pressure hoses. The clamps are installed with a special tool. They are single-use clamps; once used, they may not be reused. Proper installation is critical to ensure a full concentric clamping around the hose.

As shown in Figure 35, fuel injectors are always mounted in a rail or a specifically manufactured injector block.



Figure 35. Fuel injectors mounted on fuel rail

Figure 36 shows a GM 6.0L van installation with injectors mounted on the ignition coil brackets. The tight confines of this installation dictate the injector mounting location.



Figure 36. Fuel injectors mounted on ignition coil brackets

3.3.5 Vapor Fuel Injectors in a Dedicated Application

Vapor fuel injectors may be installed in a dedicated autogas application in either of two ways:

- Using the bifuel method described earlier in this chapter, while leaving the original gasoline injectors and fuel system intact but inoperable; or
- Removing the gasoline fuel injectors and replacing them with propane vapor fuel injectors. The fuel rail may be manufactured specially for the injectors, or the gasoline fuel rail may be modified to receive propane vapor injectors. If the gasoline fuel rail is reused, the fuel inlets may be modified with adapters or other manufacturer-specific fittings to accommodate the low-pressure fuel feed hose from the vaporizer.

In either case, the vehicle's original computer may be reprogrammed for autogas operation, while leaving most of the engine wiring intact. The fuel-system manufacturer may provide a fuel-injector support module.

3.3.6 Fuel Filters

All propane fuel systems use a fuel filter to trap any liquid-borne debris. This filter may be called the primary filter. It is located immediately upstream of the fuel lockoff solenoid.

Most vapor-injection systems use a second fuel filter to trap any debris that may be carried in the vapor stream. This debris may be formed from the inside of the fuel hoses, or by other debris or impurities that migrate through the fuel system. The vapor filter should be mounted in the hose between the vaporizer and the fuel injectors. Some of these filters may incorporate a pressure transducer to input additional electronic information.



CAUTION

The fuel feed hose between the vaporizer and the injector rails operates at approximately 25-35 psig vapor-injection pressure. To prevent hose failure, ensure sufficient clearance between any heat-producing component (*e.g.*, EGR valve or feed pipe), moving part (*e.g.*, throttle linkage, drive belts), or frequent-service item (*e.g.*, engine oil dipstick, oil filler location, air filter assembly). Also, ensure sufficient hose length to allow for engine movement without placing any strain on the hose.

Figure 37 shows an IMPCO/BRC Sequent primary fuel filter that is located directly below the red fuel lockoff coil.



Figure 37. Primary fuel filter

The Prins combined pressure transducer and secondary fuel filter shown in Figure 38 is mounted to the bulkhead. One outlet line connects to each fuel rail. The filter is serviceable by removing the mounting bolt and replacing the filter element.

The red arrow shows the electrical connection for the pressure transducer.

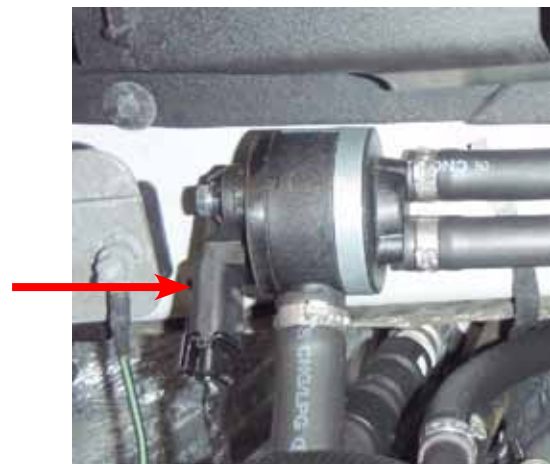

Figure 38. Secondary fuel filter, bulkhead installation

Figure 39 shows an IMPCO/BRC Sequent secondary fuel filter mounted in a single line that splits further downstream. The filter is serviceable by removing a snap-ring and replacing the filter element.

When servicing these filters and when the end cap is removed, the O-ring will not reseal properly due to oil absorption. A new O-ring must be installed.

NOTE: Other manufacturers' secondary fuel filters are placed in locations similar to those shown.



Figure 39. Secondary fuel filter, in-line installation

Figure 40 shows an IMPCO/BRC Sequent secondary fuel filter mounted in the low-pressure fuel feed hose that splits further downstream.



Figure 40. Secondary fuel filter, fuel feed hose installation

3.3.7 Programming the Auxiliary Computer

Note: This section applies only to vapor fuel-injection systems. Liquid fuel-injection systems use the original vehicle's computer, which is pre-programmed by the manufacturer.

Auxiliary computers supplied for EPA- and/or CARB-certified fuel systems should have locked fuel tables. Locked fuel tables meet EPA and CARB anti-tampering requirements and prevent unauthorized access, tampering or recalibration by unauthorized persons. Calibrations should be pre-set by the manufacturer and should not be user- or installer-adjustable.

The following steps outline the procedure used to set the initial calibration.

Start the vehicle on gasoline and allow it to reach operating temperature. The vaporizer should be hot to the touch.

- Connect an OBD-II scan tool to the vehicle's assembly line diagnostic link (ALDL) port. Observe the short-term fuel trim (STFT) reading.
- Connect a PC laptop with the appropriate diagnostic software and cable to the fuel system and initialize. Some fuel systems require the auxiliary computer to be unlocked by entering a software command or code.
- Switch the vehicle from gasoline to propane autogas. Allow the engine to stabilize. The vehicle may run rough until the programming is complete. Compare the STFT values for autogas to those for gasoline.
- Perform any pressure adjustments as required by the manufacturer before entering any modifications. The pressure should match the emissions certification.
- If required, perform the fuel-system calibration as provided by the fuel-system manufacturer or the fuel-calibration file identified for the specific vehicle, as listed by the EPA certificate of conformity or CARB executive order.
- During final fuel-system programming, note the STFT values.
- If the STFT values for autogas are positive, the fuel mixture is lean, *i.e.*, the computer is calling for more fuel. Shifting the fuel injector value (percentage above the gasoline fuel injector value) to a higher percentage may shift the STFT to zero, *i.e.*, no fuel needs to be added or subtracted.

In the readout shown in Figure 41, line 3 indicates the change in the calculated autogas injector pulse compared to the value for gasoline. In this case, the autogas pulse is set at 120 percent of the gasoline injector pulse.

This value is entered when performing STFT comparisons.

Line 4, the injector offset, is seldom modified but may be changed to add milliseconds to the current injector pulse width. The injector offset value has the most effect at idle.

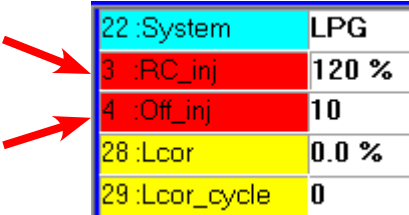

22 :System	LPG
3 :RC_inj	120 %
4 :Off_inj	10
28 :Lcor	0.0 %
29 :Lcor_cycle	0

Figure 41. Prins correction table

3.0

The STFT and LTFT values should equal those of gasoline, ensuring a close match to the desired air-fuel ratio.

All fuel systems rely on the original vehicle's ability to adapt to fuel-mixture variations within the allowable adjustment range. Some fuel systems have enough adaptability to allow transparent operation with minimal correction-table inputs. If the auxiliary computer is not programmed properly, or if an incorrect program is installed, the vehicle may exhibit erratic performance, poor fuel economy, poor emissions, or set a dash malfunction indicator lamp with a corresponding DTC.



Chapter Four

Liquid Propane Fuel-Injection Systems

CHAPTER 4: LIQUID PROPANE FUEL-INJECTION SYSTEMS

This chapter covers underhood installation procedures specific to liquid propane fuel-injection (LPFI or LPI) systems. Liquid fuel-injection systems inject liquid propane directly into the intake manifold. No cooling-system interface is required, since the fuel is not vaporized before entering the intake manifold.

Current LPFI systems are dedicated, propane-only systems. The installer removes the vehicle's gasoline fuel system in its entirety and replaces it with autogas-specific fuel lines, control systems, injectors and fuel rails. The vehicle's original powertrain control module (PCM) is reflashed and optimized for autogas service.

Underhood installation procedures specific to vapor fuel-injection systems are covered in Chapter 3.

Figure 42 shows a schematic for an LPFI system. In such a system, propane remains in the liquid phase from the tank to the injectors. A return line conveys unused fuel back to the tank. To keep the fuel liquid, an internal fuel pump adds approximately 60 to 70 psig pressure to the tank pressure. A pressure regulator or flow-control solenoid mounted in the return line maintains this pressure. The regulator or solenoid is controlled by a fuel-control processor.

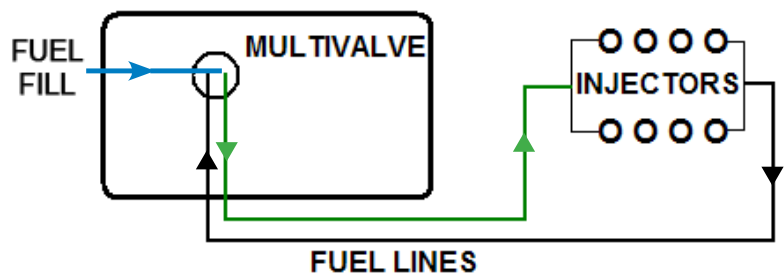

Figure 42. LPFI system schematic
Green: Supply from the tank to the injectors
Black: Fuel return line

NOTE: Fuel-line colors are for identification only. Not all LPFI fuel systems use these colors.

4.1 Removing the Gasoline Fuel System

Whenever a gasoline fuel system is disassembled, the fuel lines must first be depressurized following the vehicle manufacturer's recommended procedures. Gasoline fuel-line pressures may range from 50 to 90 psig. The lines remain pressurized even after the engine is turned off. Precautions must be taken to discharge this pressure safely, to keep pressurized fuel from being released onto the technician or onto a source of ignition.

Additional precautions must be taken when removing fuel injectors and fuel rails, pressure regulators, fuel lines, fuel tanks, evaporative emission control solenoids and wiring harnesses.

Installing the underhood components of an LPFI system reverses the process of removing the gasoline components. The following installation guide assumes that the entire gasoline fuel system has been removed according to the manufacturer's instructions.

4.2 Liquid Injection Fuel Lines

LPFI fuel systems operate at higher pressures than vapor fuel-injection systems, because the fuel must be kept in the liquid phase at all times for an LPFI system to function properly. Unlike vapor systems, LPFI systems use two fuel lines, one to supply fuel to the engine, and the other to return unused fuel to the tank. Some of these fuel lines are manufactured from composite materials, while others are metallic. Installers of LPFI systems will typically use fuel lines provided by the manufacturer. The technician should ensure that the lines are properly routed, secured to prevent movement, and insulated to prevent excess heat absorption.

As with vapor injection systems, installers should follow the LPFI system manufacturer's instructions in all cases.

4.3 Manufacturer-Specific Conversion Recommendations

The procedures described in this section may require removing the body or cab assembly from the chassis. This guide is intended to provide an overview for the installing technician, not to provide definitive instructions for a specific conversion or to substitute for the vehicle or conversion manufacturer's instructions.

Most of these procedures are performed at the fuel system manufacturer's conversion facility. They may also be performed in the field by qualified and trained technicians using special equipment.

4.3.1 Roush CleanTech

Roush CleanTech LPI fuel systems are available for Ford vehicles only.

For F-series truck conversions, Roush CleanTech recommends (but does not require) removing the cab from the chassis because of the engine setback. Removing the cab allows unimpeded access to the fuel lines and engine compartment. In severe-duty applications a cylinder-head upgrade may be recommended. This upgrade is most easily accomplished with the cab removed.

E-series vans and other vehicles may be converted without separating the cab from the chassis.

The following sections outline an F-series truck conversion with and without removing the cab.

Installer's Tip

Experienced technicians will require about 1.5 to 2 hours to remove the cab of an F-series truck. This estimate does not include preparation time, *e.g.*, for underbody cleaning if the vehicle has been in service, or for modifications such as overhead racks, front power takeoffs or frame modifications.

4.3.1.1 Conversion Without Cab Removal

1. Disconnect and remove the battery. Disconnect the negative battery terminal first.
2. Disconnect the three engine-harness connectors at the vehicle PCM and remove the PCM for express shipping to Roush to be reprogrammed. Ship the PCM to Roush using the supplied packaging. Follow the instructions on the packing label exactly to ensure timely pickup and delivery.
3. Disconnect and remove the complete air-intake assembly from the inside of the front fender to the air inlet at the engine. The air-intake assembly, including the air filter, will either not be reused or will be modified before it is reinstalled on the vehicle.
4. Disconnect the 90° air inlet at the throttle body for access to the rear of the engine compartment. The air inlet will be reused. Cover the throttle opening with several layers of masking tape or other suitable protective covering.
5. Verify that the gasoline fuel rail is depressurized. If not, depressurize the rail following the original vehicle manufacturer's recommendations. Disconnect the gasoline fuel rail connector at the driver's side rear of the engine. Remove the gasoline fuel rails and injectors.

NOTE: This step will have been completed if the gasoline tank has already been removed.

6. Install the LPI fuel rails and injectors.

NOTE: Access to the rear of the engine is extremely limited. Secure the fuel rail to the intake manifold with the provided bolts and spacers, which vary depending on the engine application.

7. Install the front crossover fuel line, *i.e.*, the line with the insulated wrapping. Verify that the flare connections on the fuel line are tight.



**SPECIAL TOOLS AND EQUIPMENT ARE
REQUIRED FOR THE FOLLOWING STEPS**

8. Place the vehicle on a suitable overhead lift. Follow the lift manufacturer's instructions for securing or positioning the vehicle for an even weight distribution.

Liquid Propane Fuel-Injection Systems

9. Lift the vehicle to a safe working height. Lower the overhead lift to a locking position.
10. Place body security screw or jack-stands at the front and rear of the vehicle to prevent tipping or rocking.
11. Place a transmission jack under the transmission. Following the vehicle manufacturer's recommendations, remove the cross-member. This may require removing or loosening the exhaust crossover pipe.
12. Loosen the front engine exhaust pipes at the manifolds. It may not be necessary to fully remove the flanges, but they should be loose enough to allow the engine to rock backwards unimpeded.
13. Allow the engine to tilt as far to the rear and downward as possible. It may be necessary to loosen the front suspension stabilizer bar assembly.
14. Remove the gasoline fuel lines from the back of the engine, at the retaining clips.
15. As shown in Figure 43, install the propane supply and return lines in the bracket at the driver's side. A small section of rubber hose may be slipped over the stainless steel fuel lines in the clamps for a secure fit.

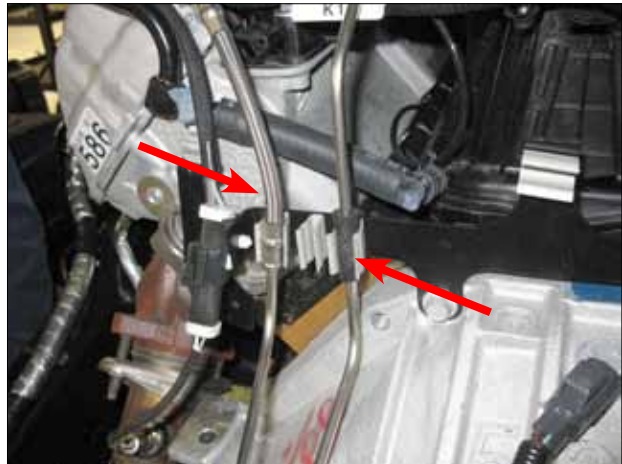

Figure 43. Propane supply and return lines

16. Thread and tighten the fuel line flare fittings into the fuel rails on the left and right side of the engine. Assistance on top of the engine may be required.
17. Before the engine and transmission are returned to their original position, run the auxiliary wiring harness from the tank to the top of the engine compartment, along the left frame rail and along the flexible fuel lines where they cross over from the frame to the transmission. Secure the wire harness with zip ties, starting at the rear.

18. As shown in Figure 44, ensure the two fuel lines are properly routed on top of the transmission and that they are not rubbing, then over to the driver's side frame rail.

The two red arrows indicate the newly installed fuel supply and return fuel lines.



Figure 44. Routing of fuel supply and return lines

19. Carefully raise the transmission jack enough to allow the transmission cross-member to be reinstalled. Tighten the retaining bolts to the manufacturer's torque specifications.
20. Tighten the exhaust pipe flanges at the exhaust manifolds.
21. Complete the installation as outlined in the companion volume *Converting Vehicles to Propane Autogas, Part 1: Installing Fuel Tanks and Fuel Lines*.

Installer's Tip

A cupcake tray helps keep removed bolts and other hardware from disappearing during disassembly.

A magnetic pad may be glued to the underside to keep the tray from sliding around.

4.3.1.2 Conversion With Cab Removal

Follow the vehicle manufacturer's recommendations for removing the cab. The following steps summarize the cab-removal process and where applicable, the related liquid propane fuel system components.



SPECIAL TOOLS AND EQUIPMENT ARE REQUIRED FOR THE FOLLOWING STEPS

1. Disconnect and remove the battery. Disconnect the negative battery terminal first.
2. Disconnect the three engine-harness connectors at the vehicle PCM and remove the PCM for express shipping to Roush to be reprogrammed. Ship the PCM to Roush using the supplied packaging. Follow the instructions on the packing label exactly to ensure prompt pickup and delivery.
3. Disconnect and remove the complete air-intake assembly from the inside of the front fender to the air inlet at the engine. The air-intake assembly, including the air filter, will either not be reused or will be modified before it is reinstalled on the vehicle.
4. Verify that the gasoline fuel rail is depressurized. If not, depressurize the rail following the original vehicle manufacturer's recommendations. Disconnect the gasoline fuel rail connector at the driver's side rear of the engine. Remove the gasoline fuel rails and injectors.

NOTE: This step will have been completed if the gasoline tank has already been removed.

5. Drain the engine coolant and either store it in an approved container for reuse or dispose of it properly. Plastic bags may be placed over the radiator hose ends and secured with zip ties to prevent leaks (Figure 45).
6. Disconnect the two automatic transmission cooling lines at the radiator. Plug or cap the hoses to prevent dripping. Plastic bags may be placed over the hose ends and secured with zip-ties to prevent leaks.



Figure 45. Radiator hose ends secured to prevent leaks

7. Using an EPA-approved recovery process, drain and recover the air-conditioning refrigerant. The air conditioning system will be separated when the cab is removed.
8. Disconnect and plug the air-conditioning refrigerant lines at the vehicle radiator core support at the condenser. Secure the lines to the vehicle body. The radiator and condenser will lift with the body; the refrigerant compressor and evaporator will stay on the engine.

9. Disconnect the brake master cylinder from the vacuum booster. Do NOT disconnect the brake lines.
10. Disconnect the brake booster vacuum hose from the booster.
11. Disconnect the coupling below the brake booster as shown in Figure 46. Notice the colored witness mark. This mark indicates that the original vehicle manufacturer has verified the proper installation of the steering shaft. Upon reassembly, the installing technician should duplicate this witness-marking step, using a colored paint pen to verify proper assembly and inspection.



Figure 46. Marking brake shaft coupling

12. Disconnect the power steering fluid reservoir from the engine and secure it to prevent spillage. The fluid reservoir will remain with the engine and chassis, but it may interfere as the body is lifted off. NOTE: This step may not be required on all models.
13. Disconnect the evaporative canister purge valve and vacuum hoses and remove the evaporative control solenoid located behind the brake booster.

Figure 47 shows the disconnected evaporative canister purge valve. This vapor management valve (VMV) solenoid and related hoses/tubing may be reused on some applications, repurposing the evaporative emission-control system.



Figure 47. Disconnected evaporative canister purge valve

14. Disconnect the vehicle wiring ground connectors at the body. Figure 48 shows one of the disconnected body-to-frame ground straps. Temporarily reinstall the bolt in the frame to prevent loss.



Figure 48. Disconnected ground strap

15. Position the vehicle lift stands under the chassis and verify the vehicle balance to prevent the body from shifting.
16. Lift the vehicle to a safe working height.
17. Underbody, disconnect the transmission wiring harness and shift control cable. Figure 49 shows the disconnected cable and wire connectors.

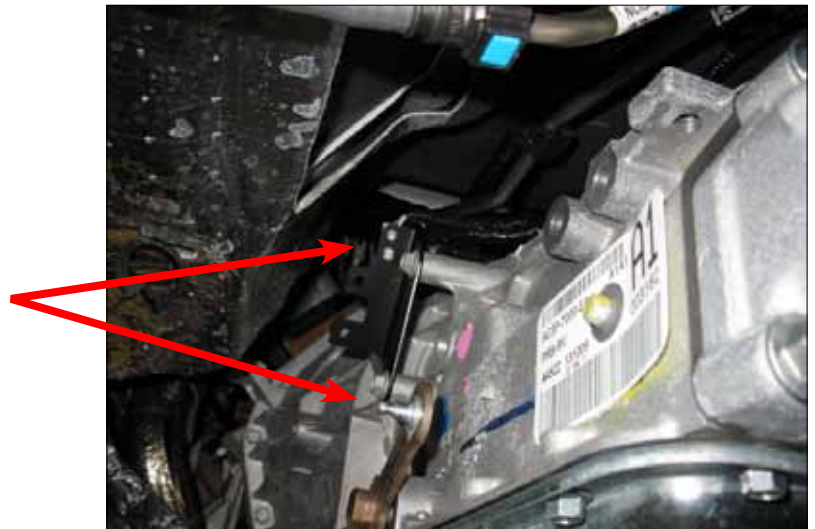

Figure 49. Disconnected cable and wire connectors

18. As shown in Figure 50, loosen the body-to-chassis mount bolts using hand tools only. Using air- or electric-powered impact wrenches to remove these bolts may break the spot welds on the captured body mount weld-nut and require significant repairs.
19. Lower the vehicle to the ground and reposition the overhead lift pads under the truck cab and body pinch-welds.



Figure 50. Loosening body-to-chassis mounting bolts with hand tools

20. Fully remove the body-to-chassis mounting bolts. These bolts may be of different lengths. Mark the bolts to identify their location when reassembling.

21. Carefully raise the overhead lift pads until the cab's weight is placed on the arms. It may be necessary to use rubber pads on the overhead lift arms as shown in Figure 51 to prevent damage to the cab.

22. Use ratchet-straps to anchor the truck cab to the overhead lift pads. Verify that the cab is secured to the lift arms (Figure 51).



Figure 51. Preparing to separate the cab from the chassis

23. Raise the cab a few inches until all of its weight is off the chassis.
24. Verify that there are no remaining ground straps, wires, cables, hoses, or other items that may prevent the total separation.

25. Raise the truck cab until it clears the rear bed. Lock the overhead lift to prevent the truck cab from lowering.
26. Roll the truck chassis forward to provide enough working clearance in the engine compartment. The cab will be suspended over the bed.



Figure 52. Lifting the cab from the chassis

Figure 53 shows the chassis after the cab has been removed. Note the full and unimpeded access to the engine and fuel system.

Complete the remaining underhood modifications as outlined in the Roush CleanTech service and installation manual.



Figure 53. Chassis following cab removal

Figure 54 shows the original gasoline fuel rail being depressurized and removed. The original rail, injectors, and IPTS sensor will not be reused.

The IPTS sensor wire connection will either be repinned or a jumper harness will be installed.



Figure 54. Removing the gasoline fuel rail

Follow Roush CleanTech's instructions to install the remaining fuel-system components. When the underhood and frame components are installed, follow the vehicle manufacturer's instructions to rejoin the cab and chassis.

An additional wiring harness will be installed. The harness connects to a relay assembly that is installed where the removed evaporative purge solenoid used to be. The new wiring harness controls the fuel pump assembly and the fill solenoid and connects to the OEM fuel pump wiring connector (for the fuel gauge). The new wire harness will also connect to the body ground and to the battery positive terminal according to the manufacturer's instructions.

Installer's Tip

While the truck cab is removed, position the new wiring harness along the top of the engine and transmission, then along the driver's side frame rail, following the original Ford wiring harness. Connect to the tank 6-pin flat plug and the original fuel-pump and fuel-gauge plug. After the truck cab is returned to the body, secure the new harness to the original harness with zip ties.

It may be helpful to lay the new wiring harness on a large workbench to help orient the technician with the harness connectors.

Auxiliary wire harness

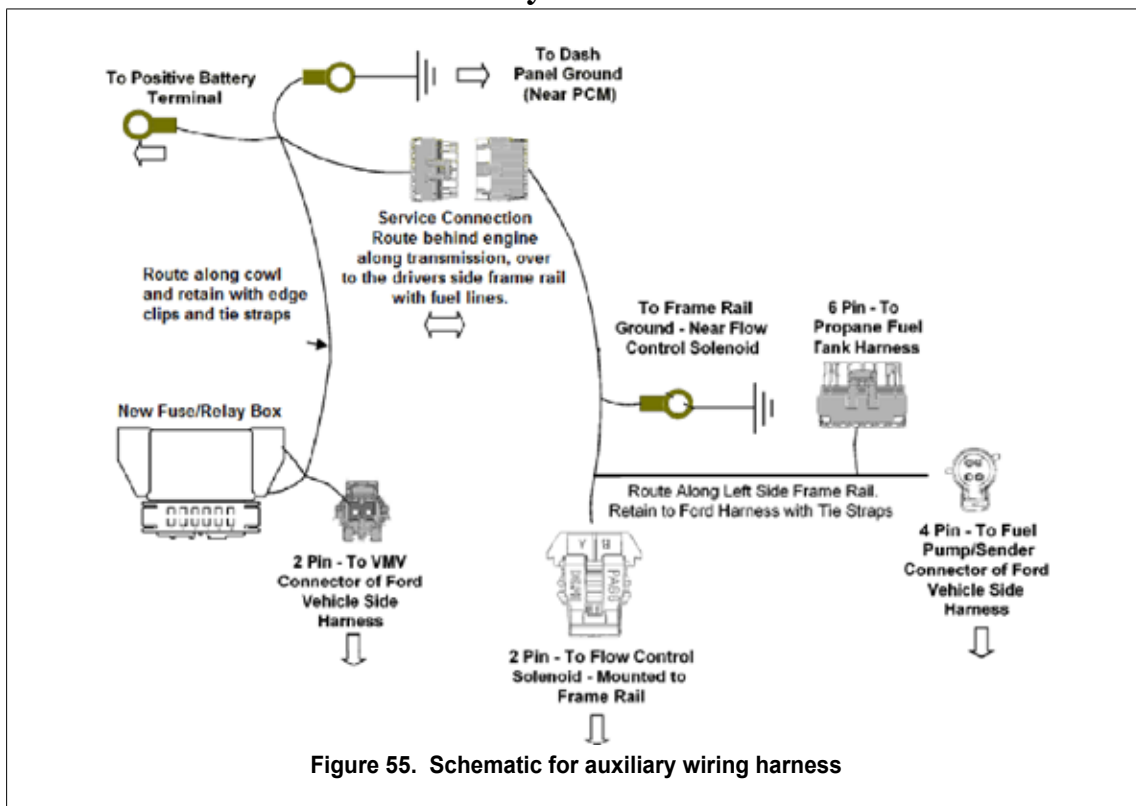

Once the cab is returned to the chassis, the underhood component installation can be completed in the reverse order of disassembly.



CAUTION

Inspect the vehicle thoroughly for leaks before releasing it to the customer.

Before the vehicle is operated, verify all liquid levels, steering shaft coupling bolt torque, brake master cylinder tightness and operation, power steering reservoir level, and air-conditioning operation.

Complete the remaining installation as outlined in the companion volume *Converting Vehicles to Propane Autogas, Part 1: Installing Fuel Tanks and Fuel Lines*.

4.3.2 CleanFuel USA LPI

CleanFuel USA's Liquid Propane Injection (LPI) fuel system is available for General Motors medium-duty applications only. The underhood components of the LPI system may be installed without removing the vehicle's cab.

1. Disconnect the battery negative terminal, then the positive terminal. The battery may be removed if desired.
2. Remove the air-cleaner assembly. It will be reused in its entirety.
3. If required, use compressed air to blow any debris from around the gasoline fuel injectors, to prevent debris from falling into the engine when the injectors are removed.
4. Remove the gasoline fuel rails with their injectors, following the original vehicle manufacturer's recommendations when depressurizing the gasoline fuel system. These components will not be reused.
5. Remove the wire harness assembly at the multi-plug connector on the engine. This is the harness that feeds the fuel injectors.
6. Install the LPI fuel rail, injectors and adapter hoses. Install the injector nozzles in the original gasoline injectors' locations.
7. Carefully remove one intake manifold bolt at a time. Attach the injector nozzle retainer brackets, using the OEM manifold bolt. Tighten the bolt to its original torque specifications.
8. Following the fuel-system manufacturer's recommendations, install the fuel pump control module bracket and module. This module is usually located near the driver's side brake booster, but may be positioned in other locations depending on the application.
9. Route the fuel pump control module's wire harness to the fuel tank multi-valve connector.

The wires may need to be extended for installation on longer-wheelbase vehicles. If the wires are extended, maintain the exact color and wire gauge as provided by the manufacturer and solder and heat-shrink each connection.

10. Connect the new wires to the battery or power junction and to the dashboard for the wait indicator lamp according to the fuel-system manufacturer's instructions.

4.4 Underhood Components of LPFI Systems

This section covers procedures that are used in more than one LPFI system. Depending on the fuel-system manufacturer's requirements, some of the vehicle's original sensors and connectors may be repurposed.

Since the gasoline fuel-control strategy is no longer required in an autogas-only installation, the vehicle's gasoline PCM is reprogrammed with the LPFI control strategy, either by the fuel-system manufacturer or on-site, depending on the application. Unused functions, such as those related to evaporative emissions, may be deleted. All other functions are retained and modified as needed to take advantage of propane's combustion characteristics.

4.4.1 Flow-Control Solenoid / Fuel-Pressure Regulator

LPFI systems control fuel flow with a solenoid mounted either at the engine or on the frame rail. This solenoid has a fixed orifice to retain some back pressure while the vehicle is running. Before the engine is started, the solenoid opens fully as the fuel pump runs, flushing partially vaporized propane back to the tank. When the engine starts, the solenoid closes.

Some liquid-injection systems incorporate a fuel-rail pressure control module (FRPCM) on selected vehicle platforms. The FRPCM is mounted on or near the engine and contains four normally closed fuel solenoids. The purpose of the module is to reduce the start delay by minimizing the amount of fuel in transit during the initial purge process. The FRPCM also bleeds down the fuel rail to the evaporative canister approximately one hour after shutoff. This prevents the fuel injectors from maintaining pressure and possibly bleeding fuel down into the intake manifold.

Liquid Propane Fuel-Injection Systems



Figure 56. CleanFUEL USA flow-control regulator

This unit has an internal regulator to stabilize fuel pressure. It is typically located on the engine, but may be located elsewhere according to the manufacturer's instructions.



Figure 57. Roush CleanTech flow-control solenoid

The solenoid has an internal orifice, but no regulator. It is located on the frame rail near the original gasoline fuel-filter location.

Figure 58 shows the Roush CleanTech fuel-rail pressure control module used on Ford E-series vans.

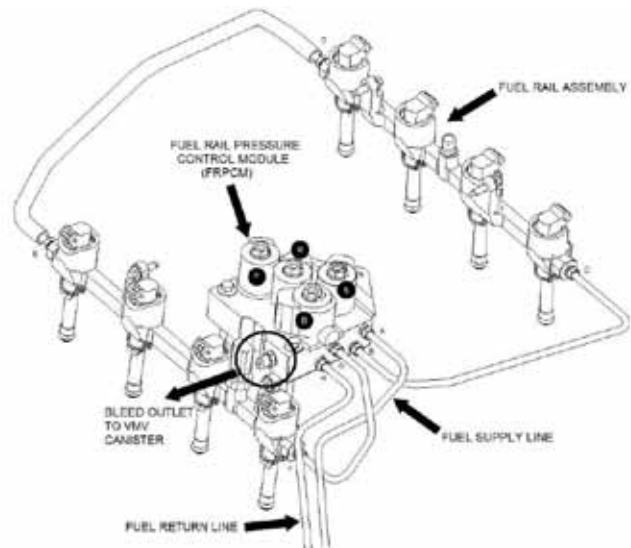

Figure 58. Roush CleanTech FRPCM

When a FRPCM is used, the vehicle retains its original evaporative control functions through the vapor-management valve (VMV).

4.4.2 Liquid Fuel Injectors

The following procedures outline a generic LPFI system installation. The fuel-system manufacturer typically supplies all needed mounting hardware, including bolts, washers, adapters and wiring harnesses. The installer will not need to supply any fuel-system-related components.

In these installations, the original gasoline fuel injectors, fuel rails and fuel lines are removed, and propane autogas injectors, fuel rails and lines are mounted in the original locations.

1. Lubricate the new injector adapter or injector housing O-rings with engine oil or a suitable O-ring lubricant.
2. Torque the newly installed injector rail and hold-down bolts to the engine manufacturer's specifications, or about 7-10 ft-lb.
3. If the injector rails are remote from the fuel injector nozzles, secure them with suitable fasteners.
4. If any other original bolts are removed and reinstalled for the installation, torque them to the manufacturer's specifications.

4.4.3 Wiring and Controls

LPGI systems require only a minimum wiring interface with the original vehicle. Most of the new wiring is supplemental, usually in the form of an added wiring harness. The new wiring harness connects to the new fuel pump, the battery, ignition sources, repurposed wiring connectors and other components, depending on the application.



Figure 59. In a Roush CleanTech LPGI fuel system, the original gasoline injection pressure and temperature sensor (IPTS) connector is repinned for the propane fuel rail pressure and temperature sensor.



Figure 60. Detail of IPTS connector

Liquid Propane Fuel-Injection Systems

Figure 61 shows a late model Ford IPTS connector and the repurposed Roush CleanTech connector.

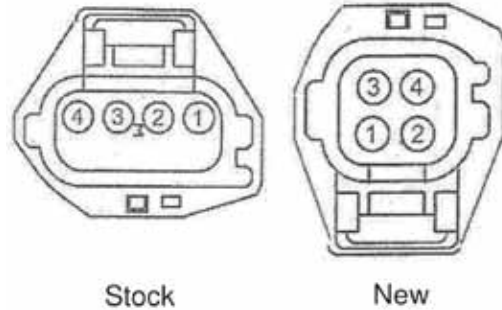

Figure 61. Roush CleanTech IPTS connector

Figure 62 shows the repinned connector, which connects to the new fuel pressure and temperature sensor mounted on the fuel rail.

NOTE: Some Roush CleanTech LPI systems use an IPTS jumper harness that does not require repinning of the connector.

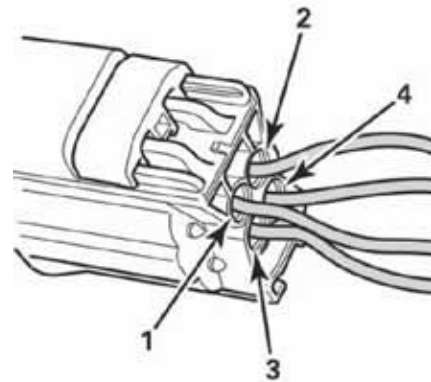

Figure 62. Repinned IPTS connector

Figure 63 shows the Roush LPFI relay control panel on a 2010 Ford F-250. The panel controls the fuel control module and fuel pump. It is mounted in the original vapor purge assembly location.



Figure 63. Relay control panel

Figure 64 shows the module used on Roush LPFI systems to control fuel-rail pressure on Ford E-series vans. The module also aids in the operation of the vapor management and evaporative emissions systems.

This module is usually located on the driver's side inner panel, behind the headlamp.



Figure 64. Fuel-rail pressure control module

Figure 65 shows the supplemental fuel-pump control module used with CleanFUEL USA's LPI fuel system. This module manages fuel-pump operation, including the purge sequence and the dash-mounted "wait" lamp.



Figure 65. CleanFUEL USA supplemental fuel-pump control module

On some engine harness assemblies, the fuel injector harness is replaced with a new harness. Other assemblies are supplemented with injector jumper harness connectors.

Figure 66 shows a short injector adapter harness that converts one style of injector connector to another. This method of adaptation is most frequently performed on a dedicated LPFI application.



Figure 66. Injector adapter harness

Liquid Propane Fuel-Injection Systems

Figure 67 shows a completed fuel-rail installation with injectors and jumper harnesses on a Roush CleanTech installation.



Figure 67. Completed Roush CleanTech fuel-rail installation

Figure 68 shows a completed CleanFUEL USA fuel-rail installation on a GM 8.1L engine installed on a Blue Bird school bus.



Figure 68. Completed CleanFUEL USA fuel-rail installation

Figure 69 shows a completed CleanFUEL USA fuel-rail installation on a GM 6.0L engine.



Figure 69. Completed CleanFUEL USA fuel-rail installation

Figures 70 and 71 show other views of a completed CleanFUEL USA fuel-rail installation on a GM 8.1L engine.



Figure 70. Completed CleanFUEL USA fuel-rail installation



Figure 71. Completed CleanFUEL USA fuel-rail installation



CAUTION

The PCM requires reprogramming on current LPFI dedicated fuel systems. If the PCM of a converted vehicle is reflashed back to gasoline operation, for example, in response to an OEM technical service bulletin (TSB), the reflash will override the LPFI software code and render the vehicle inoperable.

The diagnostic procedure to identify this fault is described in a companion module, *Troubleshooting Four Current Propane Autogas Fuel Systems*.

Contact the vehicle conversion manufacturer for assistance if the vehicle requires a PCM reflash to comply with a vehicle manufacturer's TSB.

4.4.4 LPFI Fuel Filters

LPFI vehicles utilize at least two fuel filters, one in the fuel filler hose and others in the fuel tank. The tank must be emptied of fuel prior to replacing the fuel filter.

The Roush CleanTech system includes two filters, one before and one after the fuel pump. Both filters are virtually identical to gasoline system components, but may have unique part numbers for warranty purposes.

The red arrows in Figure 72 show the locations of these two fuel filters.

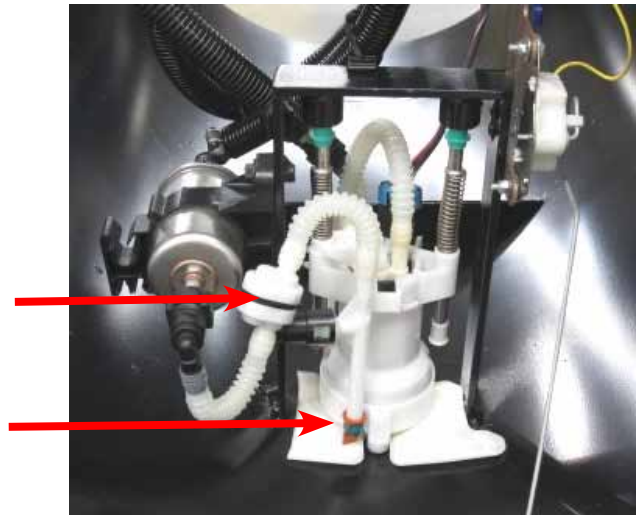

Figure 72. Roush CleanTech fuel filters

The CleanFUEL USA LPI system has one fuel filter surrounding the fuel pump inside the fuel-pump module. The filter is proprietary to the manufacturer.



Figure 73. CleanFUEL USA fuel filter



CAUTION

Inspect the vehicle thoroughly for leaks before releasing it back to the customer.

Drain and evacuate the tank following the manufacturer's recommendations. Replace the fuel filters at approximately 60,000 miles unless the vehicle's performance indicates earlier replacement. Purge the tank before refilling it after replacing the filters or completing other repairs that require opening the tank to the atmosphere.¹

4.4.5 LPFI Computer Calibration

On LPFI fuel systems, observe the short-term fuel trim and long-term fuel trim values. The values should read close to zero. If the values are reading positive, or show an "added" command, the fuel pressure may be too low and may require adjustment if authorized by the fuel-system manufacturer. Do NOT attempt to remedy any vehicle-performance issues by adjusting fuel pressure.

¹ For recommendations on emptying and purging tanks, see Chapter 4 of *Converting Vehicles to Propane Autogas, Part 1: Installing Fuel Tanks and Fuel Lines*.

Chapter Five

Quality Controls

CHAPTER 5: QUALITY CONTROLS

Before a converted vehicle is released to the customer, the technician and/or supervisor should perform a thorough inspection and test drive to ensure that the vehicle meets contract deliverables, is properly labeled, and meets all applicable performance and safety requirements. A final check by conversion facility management should confirm that these checks were completed satisfactorily and the customer has been informed about the vehicle's operational and safety features.

5.1 Pre-Delivery Inspection

1. Verify that the vehicle meets the contract deliverables:

- Tank size/volume,
- Tank location,
- Fueling receptacle location,
- Performance standards (if indicated as a contract deliverable),
- Emission compliance.

2. Install vehicle labeling and other identification requirements:

- LPG/Propane identification diamond at the right rear of the vehicle,
- EPA-required emission certification label in the engine compartment, near the original emission certification.

3. Measure the vehicle's ride height and compare against the original ride height:

- Measure in the same location as the original measurement, at the axle centerline at four corners, to the bottom of the wheel well arch or other permanent fixed part of the vehicle body.
- Document final ride height.

4. Verify that the vehicle meets all safety requirements:

- Tank installation,
- Fuel line and hose routing,
- Exhaust and moving component clearance with added fuel system items,
- Underhood component placement, clearance to engine moving parts, heat sources, crash protection, sufficient bracing and support.

5. Perform and verify a thorough leak inspection at full operating pressure, using an approved leak-check procedure:
 - Leak check using ammonia-free solution to prevent corrosion of brass fittings, or
 - Leak check using electronic detector.

6. Access the OBD-II ALDL port using laptop diagnostic program and/or OBD-II scan tool:
 - Verify short-term trim values are within the fuel-system manufacturer's standards or deviate less than 5 percent from the vehicle OEM standards;
 - Document short-term trim values.
NOTE: Long-term trim values cannot be updated until the vehicle accumulates substantial post-conversion mileage.

7. Perform system-specific software diagnostics and validate any software updates for added PCMs (if used):
 - Diagnose and resolve any faults;
 - Verify and document the outlet pressure under cold and hot conditions in accordance with the fuel-system manufacturer's instructions;
 - Adjust system pressure if required; document final delivery pressure.

8. Conduct final performance test drive.

5.2 Final Performance Test Drive

The final performance test drive should include:

Cold and hot starting

- Cold start means at least four hours since last restart.
- Hot start means within 10 minutes of last restart. If the vehicle has electric cooling fans, they should cycle at least once without the air conditioning being engaged. This procedure verifies that the engine is at full operating temperature.
- The laptop diagnostic program should verify that the vaporizer is also at the normal operating temperature, *i.e.*, at least 80°C.

Extended idle

- Test idling and under load with the transmission and air conditioning engaged. The vehicle should idle in gear for at least 10 minutes with no issues.

- No erratic idle speed (hunting or surging).
- A stable idle speed indicates that the system is maintaining a stable air-fuel ratio, even if the oxygen sensor cools outside of its normal operating range.

Firm acceleration

- From a steady idle, accelerate briskly to highway speeds at almost full throttle without over-revving the engine, to simulate entering a highway on-ramp and merging with traffic.
- Verify satisfactory performance.

Cruise control (if equipped)

- Engage cruise control at highway speed.
- Verify that the vehicle maintains steady speed for at least five minutes.

Fuel cut-off during deceleration

- At highway speeds, disengage cruise control (if equipped) or lift off of the throttle and allow the vehicle to coast to less than 10 miles per hour.
- The engine should show no signs of dying or hesitation.

Idle speed controller

- Allow the engine to idle; then occasionally depress the throttle to reach speeds of no more than 5 miles per hour and stop frequently, as if in a parking lot.
- Verify that the idle speed controller maintains a stable transition from idle to low speed.

Idle control and injector cutout circuit

- At highway speeds, firmly depress the brake pedal to bring the vehicle to a full stop without locking the brakes or allowing the vehicle to get out of control.
- The engine should not die or surge during this test.
- This test verifies that the engine idle control and injector cut-out circuit are operating and re-engaging properly when the engine reaches its pre-set fuel cut reactivation speed.

5.3 Final Delivery Inspection Checklist

Immediately prior to the customer accepting the vehicle, the conversion facility management should ensure that:

- All technician and supervisor checklists and confirmations are complete. The technician should have a checklist with supervisor validation at each step of the conversion process.
- The vehicle has an owner's manual, warranty card, and any operator training material. Information about autogas fueling locations may be included.
- The vehicle is properly fueled.
- The operator has been informed about:
 - o Starting the vehicle;
 - o Automatic and manual switching back and forth between autogas and gasoline (bifuel vehicle only);
 - o Out-of-gasoline emergency starting (gasoline-start bifuel vehicle only)
 - Describe emergency starting procedure,
 - Describe limited number of forced restarts, if applicable.
 - o The importance of not allowing the fuel system to run near empty. This is especially important on dedicated LPI applications.
 - o Vehicle fueling procedures
 - Vacate the vehicle;
 - Vehicle- or system-specific fueling requirements;
 - Optimal fueling conditions, *i.e.*, some liquid injection systems may require longer refueling times or special fueling schedules;
 - Emergency shutoff switch location at fueling station.
 - o Emergency reporting procedures, whom to contact.
 - o Emergency procedures the vehicle operator can perform:
 - Turn the ignition switch off;
 - Operation of manual or electronic shutoff valves.

Appendices

APPENDIX A: VAPOR PRESSURE INDEX CHART

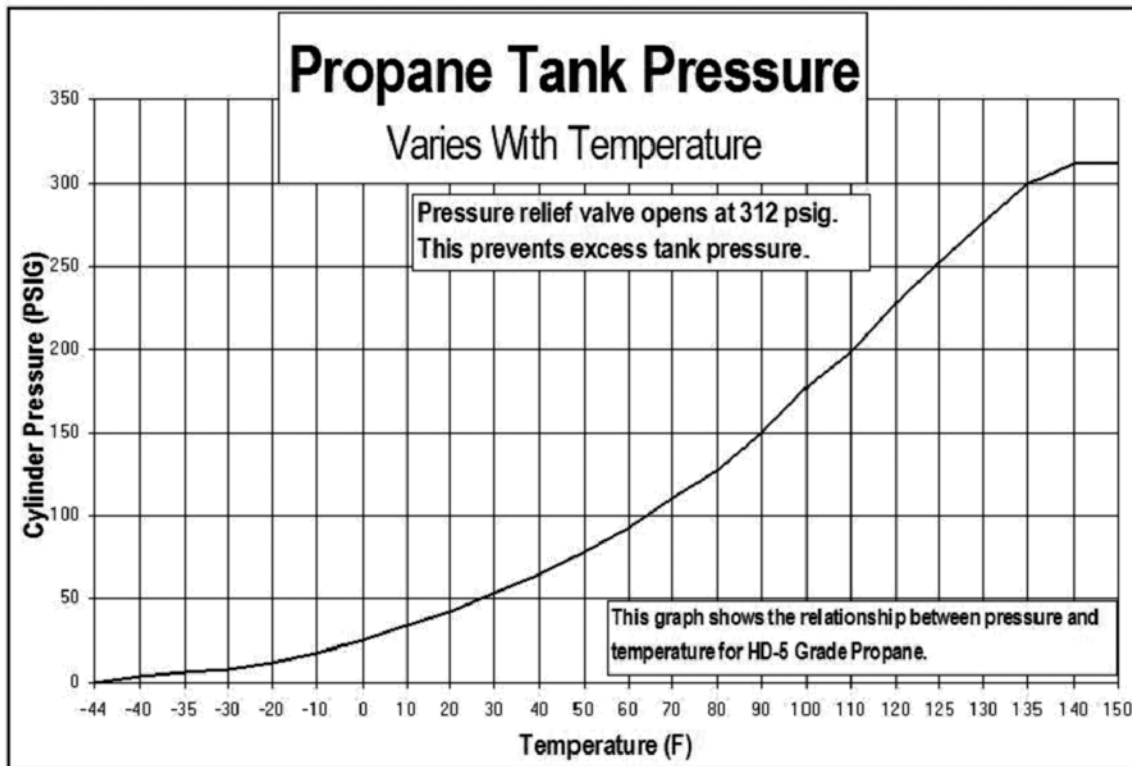

This chart illustrates the relation between propane temperature and pressure.

Pressure and temperature may be plotted on the chart above by measuring the pressure at the outlet of a propane container and the ambient temperature.

Assuming the ambient temperature is 70°F, place the point directly above the 70° mark at the curved line. At this reference point, draw a line directly to the left. We see a pressure of approximately 109-120 psig. This is the vapor pressure inside the tank. The pressure may vary depending on the fuel mixture, but typically less than 10 percent. If the variance is greater than 20 percent, the tank contents might be tested to identify which fuel is present in the greatest concentration.

Any point above and to the left of the curved line indicates propane in liquid form. Any point below and to the right of the curved line indicates propane in vapor form. The curved line indicates saturation or equilibrium. At any point along this line, if pressure is added or the temperature is reduced, propane vapor condenses to liquid. Similarly, if the pressure is reduced or the temperature is increased, propane liquid boils and becomes vapor.

The curved line describes the pressure needed to keep propane in liquid form, which is the pressure available to provide the necessary force to feed propane to the engine.

APPENDIX B: MATERIAL SAFETY DATA SHEET

Material Safety Data Sheet

Odorized Propane

1. CHEMICAL PRODUCT AND COMPANY IDENTIFICATION

Product Name: Odorized Commercial Propane
Chemical Name: Propane
Chemical Family: Hydrocarbon
Formula: C₃H₈
Synonyms: Dimethylmethane, LP-Gas, Liquefied Petroleum Gas (LPG), Propane, Propyl Hydride
Transportation Emergency No.: 800/424-9300 (CHEMTRAC)

Material Safety Data Sheet – Odorized Propane

1. CHEMICAL PRODUCT AND COMPANY IDENTIFICATION

Product Name: Odorized Commercial Propane
 Chemical Name: Propane
 Chemical Family: Hydrocarbon
 Formula: C₃H₈
 Synonyms: Dimethylmethane, LP-Gas, Liquefied Petroleum Gas (LPG), Propane, Propyl Hydride

Transportation Emergency No. 800/424-9300 (CHEMTRAC) Emergency Number:

2. COMPOSITION/INFORMATION ON INGREDIENTS

INGREDIENT NAME / CAS NUMBER	PERCENTAGE	OSHA PEL
Propane / 74-98-6	87.5-100	1000 ppm
Ethane / 74-84-0	0-7.5	
Propylene / 115-07-1	0-10.0	
Butanes/various	0-2.5	
Ethyl Mercaptan / 75-08-1	16-25 ppm	0.5 ppm

3. HAZARDS IDENTIFICATION

EMERGENCY OVERVIEW
DANGER! Flammable liquefied gas under pressure. Move away from heat, sparks, flames, and all other ignition sources. Vapor replaces oxygen available for breathing and may cause suffocation in confined spaces. Use only with adequate ventilation. Odor may not provide adequate warning of potentially hazardous concentrations. Vapor is heavier than air. Liquid can cause freeze burn similar to frostbite. Do not get liquid in eyes, on skin, or on clothing. Avoid breathing of vapor. Keep container valve closed when not in use.

POTENTIAL HEALTH EFFECTS INFORMATION
ROUTES OF EXPOSURE: Inhalation. It should be noted that before authorization could occur, the lower flammability limit of propane is 2.1% by volume in air.

NFPA 704 Hazard Identification System

2. COMPOSITION/INFORMATION ON INGREDIENTS

INGREDIENT NAME / CAS NUMBER	PERCENTAGE	OSHA PEL
Propane / 74-98-6	87.5-100	
Ethane / 74-84-0	0-7.5	1000 ppm
Propylene / 115-07-1	0-10.0	
Butanes/various	0-2.5	
Ethyl Mercaptan / 75-08-1	16-25 ppm	0.5 ppm

3. HAZARDS IDENTIFICATION

EMERGENCY OVERVIEW - NFPA 704 - Hazard Identification System

DANGER! Flammable liquefied gas under pressure. Keep away from heat, sparks, flame, and all other ignition sources. Vapor replaces oxygen available for breathing and may cause suffocation in confined spaces. Use only with adequate ventilation. Odor may not provide adequate warning of potentially hazardous concentrations. Vapor is heavier than air. Liquid can cause freeze burn similar to frostbite. Do not get liquid in eyes, on skin, or on clothing. Avoid breathing of vapor. Keep container valve closed when not in use.



POTENTIAL HEALTH EFFECTS INFORMATION

Routes of Exposure:

Inhalation: Asphyxiant. It should be noted that before suffocation could occur, the lower flammability limit of propane in air would be exceeded, possibly causing both an oxygen-deficient and explosive atmosphere. Exposure to concentrations >10% may cause dizziness. Exposure to atmospheres containing 8%-10% or less oxygen will bring about unconsciousness without warning, and so quickly that the individuals cannot help or protect themselves. Lack of sufficient oxygen may cause serious injury or death.

Eye Contact: Contact with liquid can cause freezing of tissue.

Skin Contact: Contact with liquid can cause frostbite.

[Skin Absorption]: None.

[Ingestion]: Liquid can cause freeze burn similar to frostbite. Ingestion not expected to occur in normal use.

Chronic Effects: None.

Medical Conditions Aggravated by Overexposure: None.

Other Effects of Overexposure: None.

Carcinogenicity: Propane is not listed by NTP, OSHA or IARC.

4. FIRST AID MEASURES

INHALATION:

Persons suffering from lack of oxygen should be removed to fresh air. If victim is not breathing, administer artificial respiration. If breathing is difficult, administer oxygen. Obtain prompt medical attention.

EYE CONTACT:

Contact with liquid can cause freezing of tissue. Gently flush eyes with lukewarm water. Obtain medical attention immediately.

SKIN CONTACT:

Contact with liquid can cause frostbite. Remove saturated clothes, shoes and jewelry. Immerse affected area in lukewarm water not exceeding 105°F. Keep immersed. Get prompt medical attention.

INGESTION: If swallowed, get immediate medical attention.

NOTES TO PHYSICIAN: None.

5. FIRE-FIGHTING MEASURES

FLASH POINT: -156°F (-104°C)

AUTOIGNITION: 842°F (432°C)

IGNITION TEMPERATURE IN AIR: 920-1120°F

FLAMMABLE LIMITS IN AIR BY VOLUME: Lower: 2.15% Upper: 9.6%

EXTINGUISHING MEDIA: Dry chemical, CO₂, water spray or fog for surrounding area. Do not extinguish fire until propane source is shut off.

SPECIAL FIRE-FIGHTING INSTRUCTIONS: Evacuate personnel from danger area. Evacuated personnel should stay upwind, and away from tank ends, and move to a distance at least 1 mile or more away from containers subject to direct flame. Immediately cool container(s) (especially upper half) with water spray from maximum distance and the sides of containers, taking care not to extinguish flames. If flames are extinguished, explosive re-ignition may occur. Stop flow of gas, if possible without risk, while continuing cooling water spray.

UNUSUAL FIRE AND EXPLOSION HAZARDS: Propane is easily ignited. It is heavier than air; therefore, it can collect in low areas while dissipating. Vapors may be moved by wind or water spray. Vapors may move to areas where ignition sources are present and ignite, flashing back to the source. Pressure in a container can build up due to heat and container may rupture if pressure relief devices should fail to function.

HAZARDOUS COMBUSTION PRODUCTS: In typical use in properly adjusted and maintained gas appliances--None. If propane combustion is incomplete, poisonous carbon monoxide (CO) may be produced. Defective, improperly installed, adjusted, maintained, or improperly vented appliances may produce carbon monoxide or irritating aldehydes.

6. ACCIDENTAL RELEASE MEASURES

STEPS TO BE TAKEN IF MATERIAL IS RELEASED OR SPILLED: Evacuate the immediate area. Eliminate any possible sources of ignition and provide maximum ventilation. Shut off source of propane, if possible. If leaking from container or valve, contact your supplier and/or fire department.

7. HANDLING AND STORAGE

HANDLING PRECAUTIONS: Propane vapor is heavier than air and can collect in low areas that are without sufficient ventilation. Leak-check system with a leak detector or approved solution, never with flame. Make certain the container service valve is shut off prior to connecting or disconnecting. If container valve does not operate properly, discontinue use and contact supplier. Never insert an object (*e.g.*, wrench, screwdriver, pry bar, etc.) into pressure relief valve or cylinder cap openings. Do not drop or abuse cylinder. Never strike an arc on a gas container or make a container part of an electrical circuit. See [Section] 16.

OTHER INFORMATION for additional precautions.

STORAGE PRECAUTIONS: Store in a safe, authorized location (outside, detached storage is preferred) with adequate ventilation. Specific requirements are listed in NFPA 58, *Liquefied Petroleum Gas Code*. Isolate from heat and ignition sources. Containers should never be allowed to reach temperature exceeding 125°F (52°C). Isolate from combustible materials. Provide separate storage locations for other compressed and flammable gases. Propane containers should be separated from oxygen cylinders, or other oxidizers, by a minimum distance of 20 feet, or by a barrier of non-combustible material at least 5 feet high, having a fire rating of at least 1 hour. Full and empty cylinders should be segregated. Store cylinders in upright position, or with pressure relief valve in

vapor space. Cylinders should be arranged so that pressure relief valves are not directed toward other cylinders. Do not drop or abuse cylinders. Keep container valve closed and plugged or capped when not in use. Install protective caps when cylinders are not connected for use. Empty containers retain some residue and should be treated as if they were full.

8. EXPOSURE CONTROLS/PERSONAL PROTECTION

ENGINEERING CONTROLS

Ventilation:

Provide ventilation so propane does not reach a flammable mixture.

Ignition Source Control:

Electrical wiring in liquid transfer areas must be Class I, Group D, and explosion-proof. Other possible ignition sources should be kept away from transfer areas. NO SMOKING signs should be posted at all approaches and entries to transfer areas. Transfer and storage areas must be kept free of flammables, combustibles and vegetation.

RESPIRATORY PROTECTION (SPECIFY TYPE)

General Use: None.

Emergency Use:

If concentrations are high enough to warrant supplied-air or self-contained breathing apparatus, then the atmosphere may be flammable (See Section 5). Appropriate precautions must be taken regarding flammability.

PROTECTIVE CLOTHING:

Avoid skin contact with liquid propane because of possibility of freeze burn. Wear gloves and protective clothing which are impervious to the product for the duration of the anticipated exposure.

EYE PROTECTION:

Safety glasses are recommended when filling and handling cylinders.

OTHER PROTECTIVE EQUIPMENT:

Safety shoes are recommended when handling cylinders.

9. EXPOSURE CONTROLS/PERSONAL PROTECTION

BOILING POINT: @ 14.7 psia = -44°F

SPECIFIC GRAVITY (DENSITY) OF VAPOR (Air = 1) at 60°F: 1.50

SPECIFIC GRAVITY OF LIQUID (Water = 1) at 60°F: 0.504

VAPOR PRESSURE: @ 70°F = 127 psig @ 105°F = 210 psig

EXPANSION RATIO (from liquid to gas @ 14.7 psia): 1 to 270

SOLUBILITY IN WATER: Slight, 0.1 to 1.0%

APPEARANCE AND ODOR: A colorless and tasteless gas at normal temperature and pressure. An odorant has been added to provide a strong unpleasant odor.

ODORANT WARNING: Odorant is added to aid in the detection of leaks. One common odorant is ethyl mercaptan, CAS No. 75-08-01. Odorant has a foul smell. The ability of people to detect odors varies widely. In addition, certain chemical reactions with material in the propane system, or fugitive

propane gas from underground leaks passing through certain soils can reduce the odor level. No odorant will be 100% effective in all circumstances. If odorant appears to be weak, notify propane supplier immediately.

10. STABILITY AND REACTIVITY

STABILITY: Stable.

Conditions to avoid: Keep away from high heat, strong oxidizing agents and sources of ignition.

REACTIVITY:

Hazardous Decomposition Products: Products of combustion are fumes, smoke, carbon monoxide and aldehydes and other decomposition products. Incomplete combustion can cause carbon monoxide, a toxic gas, while burning or when used as an engine fuel.

Hazardous polymerization: Will not occur.

11. TOXICOLOGICAL INFORMATION

Propane is non-toxic and is a simple asphyxiant; however, it does have slight anesthetic properties and higher concentrations may cause dizziness.

[IRRITANCY OF MATERIAL]: None

[SENSITIZATION TO MATERIAL]: None

[REPRODUCTIVE EFFECTS]: None

[TERATOGENICITY]: None

[MUTAGENICITY]: None

[SYNERGISTIC MATERIALS]: None

12. ECOLOGICAL INFORMATION

No adverse ecological effects are expected. Propane does not contain any Class I or Class II ozone-depleting chemicals (40 CFR Part 82.) Propane is not listed as a marine pollutant by DOT (49 CFR Part 171).

13. DISPOSAL CONSIDERATIONS

WASTE DISPOSAL METHOD:

Do not attempt to dispose of residual or unused product in the container. Return to supplier for safe disposal.

Residual product within process system may be burned at a controlled rate, if a suitable burning unit (flare stack) is available on site. This shall be done in accordance with federal, state and local regulations.

14. TRANSPORTATION INFORMATION

DOT SHIPPING NAME: Liquefied Petroleum Gas

HAZARD CLASS: 2.1 (Flammable Gas)

IDENTIFICATION NUMBER: UN 1075

PRODUCT RQ: None

SHIPPING LABEL(S): Flammable gas

IMO SHIPPING NAME: Propane

PLACARD (When Required): Flammable gas

IMO IDENTIFICATION NUMBER: UN 1978

SPECIAL SHIPPING INFORMATION:

Container should be transported in a secure, upright position in a well-ventilated vehicle.

15. REGULATORY INFORMATION

The following information concerns selected regulatory requirements potentially applicable to this product. Not all such requirements are identified. Users of this product are responsible for their own regulatory compliance on a federal, state [provincial] and local level.

U.S. FEDERAL REGULATIONS:

EPA - Environmental Protection Agency

CERCLA - Comprehensive Environmental Response, Compensation and Liability Act of 1980
(40 CFR Parts 117 and 302):
Reportable Quantity (RQ): None

SARA - Superfund Amendment and Reauthorization Act

- **SECTIONS 302/304:** Require emergency planning on threshold planning quantities (TPQ) and release reporting on reportable quantities (RQ) of EPA extremely hazardous substances (40 CFR Part 355).

Extremely Hazardous Substances: None

Threshold Planning Quantity (TPQ): None

- **SECTIONS 311/312:** Require submission of material safety data sheets (MSDSs) and chemical inventory reporting with identification of EPA-defined hazard classes (40 CFR Part 370). The hazard classes for this product are:

IMMEDIATE: Yes

PRESSURE: Yes

DELAYED: No

REACTIVITY: No

FLAMMABLE: Yes

- **SECTION 313:** Requires submission of annual reports of release of toxic chemicals that appear in 40 CFR Part 372.

Propane does not require reporting under Section 313.

40 CFR PART 68 Risk Management for Chemical Accidental Release

TSCA - Toxic Substance Control Act

Propane is not listed on the TSCA inventory.

OSHA - Occupational Safety and Health Administration

29 CFR 1910.119: Process Safety Management of Highly Hazardous Chemicals.

FDA - Food and Drug Administration

21 CFR 184.1655: Generally recognized as safe (GRAS) as a direct human food ingredient when used as a propellant, aerating agent and gas.

16. OTHER INFORMATION

SPECIAL PRECAUTIONS: Use piping and equipment adequately designed to withstand pressures to be encountered.

NFPA 58 *Liquefied Petroleum Gas Code* and OSHA 29 CFR 1910.110 require that all persons employed in handling LP-gases be trained in proper handling and operating procedures, which the employer shall document. Contact your propane supplier to arrange for the required training. Allow only trained and qualified persons to install and service propane containers and systems.

WARNING: Be aware that with odorized propane, the intensity of ethyl mercaptan stench (its Odor) may fade due to chemical oxidation (in the presence of rust, air or moisture), adsorption or absorption. Some people have nasal perception problems and may not be able to smell the ethyl mercaptan stench. Leaking propane from underground lines may lose its odor as it passes through certain soils. While ethyl mercaptan may not impart the warning of the presence of propane in every instance, it is generally effective in a majority of situations. Familiarize yourself, your employees and customers with this warning and other facts associated with the so-called odor-fade phenomenon. If you do not already know all the facts, contact your propane supplier for more information about odor, electronic gas alarms and other safety considerations associated with the handling, storage and use of propane.

Issue Date: November, 2001

ISSUE INFORMATION

This material safety data sheet and the information it contains is offered to you in good faith as accurate. Much of the information contained in this data sheet was received from outside sources. To the best of our knowledge this information is accurate, but the Propane Education and Research Council does not guarantee its accuracy or completeness. Health and safety precautions in this data sheet may not be adequate for all individuals and/or situations. It is the user's obligation to evaluate and use this product safely, comply with all applicable laws and regulations and to assume the risks involved in the use of this product.

Appendix B: Material Safety Data Sheet

NO WARRANTY OF MERCHANTABILITY, FITNESS FOR ANY PARTICULAR PURPOSES, OR ANY OTHER WARRANTY IS EXPRESSED OR IS TO BE IMPLIED REGARDING THE ACCURACY OR COMPLETENESS OF THIS INFORMATION, THE RESULTS TO BE OBTAINED FROM THE USE OF THIS INFORMATION OR THE PRODUCT, THE SAFETY OF THIS PRODUCT, OR THE HAZARDS RELATED TO ITS USE.

The purpose of this MSDS is to set forth general safety information and warnings related to the use of propane. It is not intended to be an exhaustive treatment of the subject, and should not be interpreted as precluding other authoritative information or safety procedures which would enhance safe LP-gas storage, handling or use. Issuance of this MSDS is not intended nor should it be construed as an undertaking to perform services on behalf of any party either for their protection or for the protection of third parties. The Propane Education and Research Council assumes no liability for reliance on the contents of this material safety data sheet.

APPENDIX C: GLOSSARY

Some of the terms used in this module are defined in National Fire Protection Association (NFPA) Pamphlet 58, *Liquefied Petroleum Gas Code*. The list below is not exhaustive. Its purpose is to explain terms commonly used in this manual and in the propane and automotive industries.

NOTE: Some autogas fuel systems use European components. In these cases the manufacturer's literature or diagnostic software may use European units or references.

Air-Fuel Ratio

The ratio of air to fuel in a mixture, expressed either by volume or by weight. For propane, the ideal air-fuel ratio by volume is 24:1, *i.e.*, 24 parts air to 1 part fuel. The ideal ratio by weight is 15.5:1, *i.e.*, 15.5 pounds of air to 1 pound of fuel.

An air-fuel ratio may be expressed as an AF number. In this system, the ideal ratio is defined as AF = 1. An AF ratio greater or less than 1 indicates a rich or lean mixture, respectively. AF 1.1 means the mixture is 10 percent richer than the ideal ratio, and AF 0.9 means the mixture is 10 percent leaner than the ideal ratio. See also Lambda.

ALDL Assembly Line Diagnostic Link. The connection located near the steering column that allows OBD-II access to the vehicle's electronic control module.

Amps Short for amperage, a unit for measuring the strength of an electrical current.

Autogas The international term for LP-gas mixtures used to propel highway vehicles. In the U.S., autogas is at least 90 percent propane, and the terms "autogas," "propane," and "propane autogas" are used interchangeably. Elsewhere "autogas" may refer to mixtures of propane and butane in various proportions. See also HD-5.

Bifuel A vehicle capable of operating on either of two fuels, but not at the same time, *e.g.*, autogas or gasoline. See Dual Fuel.

California Title 13

The part of the *California Code of Regulations* that sets out California Air Resources Board (CARB) emissions standards.

CAN/CSA-B.149.5-10

The Canadian Standards Association's installation code for propane fuel systems and tanks on highway vehicles.

- CARB** California Air Resources Board, sometimes abbreviated ARB. The state agency that sets emissions standards for vehicles in California. Any converted vehicle bought or sold in California must meet CARB emissions standards. Some other states adopt CARB emissions standards.
- Code** A legally enforceable standard that has been adopted by an authority having jurisdiction.
- Converter**
Generic term for a device that converts propane liquid to propane vapor and incorporates a pressure regulator that reduces tank pressure to the pressure required by the engine. The term is sometimes used interchangeably with vaporizer, reducer, regulator or vaporizing regulator. See Vaporizer.
- Convolute Wire Loom**
Flexible, ribbed plastic tubing that is split open for the insertion of a wire harness. Convolute wire loom provides abrasion resistance and professional appearance. Convolute wire loom rated for automotive use should resist heat and UV degradation.
- Crimp Connector**
A connector used to join two or more pieces of wire by squeezing them together in a small metal tube. Applying solder to the coupling provides additional mechanical strength. Most crimped couplings are solderless and have a loose plastic insulating sleeve. Others incorporate low-temperature solder and heat shrink tubing in addition to the crimp.
- DTC** Diagnostic Trouble Code. Generic term for a code sent from a vehicle's electronic control module indicating a specific malfunction in the vehicle's emissions control system. The code may be cross-referenced to help identify the fault. See ECM/PCM/ECU.
- Dual Fuel** A vehicle capable of operating on a mixture of two fuels at the same time, *e.g.*, autogas and diesel. See Bifuel.
- ECM/PCM/ECU**
Electronic Control Module, Powertrain Control Module, and Electronic Control Unit, respectively. The terms are interchangeable and do not identify a manufacturer or brand-specific component. An ECM/PCM/ECU controls all engine functions, including emission controls and throttle position. Some aftermarket fuel systems use a supplemental module as an interceptor or translator. Dedicated liquid propane fuel-injection systems typically use the original PCM, repurposed for propane.
- ECT** Engine Coolant Temperature. The ECT sensor measures the temperature of the engine coolant. The output is measured in ohms.

EPA U.S. Environmental Protection Agency. EPA oversees the testing and certification of engine fuel systems to verify compliance with applicable emissions standards. Vehicles converted to propane must comply fully with the EPA emissions regulations in effect at the time of the conversion.

Flow Control Module

A component of a liquid propane fuel-injection system that allows partially vaporized fuel to be flushed from the fuel rails back to the fuel tank.

Fuel Filter

A filter designed to trap debris particles, typically 40 microns down to 10 microns (40 μ -10 μ) in size, that may be partially dissolved or suspended in fuel. These particles include rust, tank scale, and rubber compounds from deteriorating hoses that may enter the fuel during transportation or storage. Typical filter media are pleated paper, sintered bronze, wound or woven string, compressed polyester or cotton fiber or fiber resin.

Fuel Injector

An electrical solenoid, controlled by a vehicle's computer, that precisely meters fuel to the cylinders of an engine. The duration of the energized pulse determines how much fuel enters the cylinder. See Pulse Width.

Fuel Rail The component of an engine that houses the fuel injectors. On most autogas fuel systems, the fuel injectors are mounted separately from the engine intake manifold, mainly to isolate them from heat, but also for installation and future service access if the vehicle is bifuel. The fuel rail may also house the fuel pressure and temperature sensors.

Fuel Rail Pressure Control Module

A unit that combines the fuel control module and other fuel flow solenoids into one module in a liquid propane fuel-injection system. The purpose is to reduce the amount of fuel in transit and to reduce wait time during the purge cycle. The unit also reduces pressure in the fuel rail, minimizing the chances of an injector leak-down. See LPPFI.

Fuel Transfer Hose

A small hose that connects a fuel injector to the intake manifold nozzle. The length and location of the fuel transfer hose should be dictated by the manufacturer to comply with emission certifications. See Nozzle.

HD-5 A specification for propane autogas. "HD" means heavy duty, and "5" means no more than 5 percent propylene by volume is permitted in the fuel mixture. HD-5 propane typically conforms to ASTM 1835, which specifies a maximum of 5 percent propylene, a minimum of 90 percent propane, and the remainder trace gases. A maximum vapor pressure of 208 psig at 100°F effectively limits the amount of higher-pressure ethane in the mixture.

HD-10 Unofficial term for LPG with up to 10 percent propylene that meets the specifications set out in the *California Code of Regulations*, Title 13, Section 2292.6.

Heat-Shrink Tubing

Tubing that shrinks when heat is applied, typically used to provide insulation for electrical wiring connections.

Injector Offset

An adjustment of an engine's fuel injection timing and rate that accounts for the different properties of propane fuel. A supplemental module performs the adjustment, typically by starting the injection sequence earlier and extending injector on-time by up to 30 percent from the gasoline setting. Injector offset is affected by the fuel's volume, mass and inertial properties as well as by fuel pressure and temperature, the length and location of fuel transfer hoses, and engine operational functions. See Pulse Width and Fuel Injector.

IPTS Injection Pressure and Temperature Sensor. This sensor detects the temperature and pressure of the fuel and sends the data to the PCM to determine whether propane is in the liquid or vapor phase. The IPTS is sometimes located on the fuel rail. See Vapor Pressure.

Lambda A measure of a fuel mixture's air-to-fuel ratio, represented by the Greek letter lambda (λ). Lambda=1.0 means an ideal air-fuel ratio. NOTE: Lambda values are the reverse of AF ratios. $\lambda=1.1$ means the mixture has 10 percent excess air, i.e., is leaner than ideal. $\lambda=0.9$ means the mixture has 10 percent too little air, i.e., is richer than ideal. See Air-Fuel Ratio; Stoichiometry.

Lockoff Solenoid

Also called a fuel lock solenoid. An electrical solenoid that controls the flow of fuel from the storage tank to the engine. A fuel system may include more than one solenoid.

LPG Liquefied Petroleum Gas. Any material having a vapor pressure not exceeding that allowed for commercial propane that is composed predominantly of the following hydrocarbons, either by themselves or as a mixture: propane, propylene, butane (normal or iso-butane) and butylene.¹

LPI, LPFI Liquid Propane Injection, Liquid Propane Fuel Injection. A technology in which propane liquid instead of propane vapor is injected into the intake manifold of an engine. See LPFFI.

LPPFI Liquid Phase Propane Fuel Injection. See LPI, LPFI.

MAP Manifold Absolute Pressure. The MAP sensor shows the engine load by measuring the pressure inside the intake manifold. The output is measured in volts.

¹ NFPA 58, §3.3.36 2008 edition; NFPA 58, §3.3.34 2011 edition

Mass Air Flow (MAF)

The amount of air entering the engine, measured by weight. A MAF sensor calculates the mass of the incoming air based on variables such as inlet air temperature, air pressure, relative humidity and engine speed to trim the engine's air-fuel ratio.

MIL Malfunction Indicator Light. An amber dashboard light indicating that service is needed but the fault is not an emergency. Also known as the Check Engine Light or the Service Engine Soon light.

MSDS Material Safety Data Sheet. A document that describes the physical and chemical properties of a product and provides health and safety information related to the product's storage, use and disposal. See Appendix A.

NFPA National Fire Protection Association. NFPA publishes codes and standards that are adopted by many U.S. jurisdictions. NFPA 58, *Liquefied Petroleum Gas Code*, includes standards on propane retrofit fuel systems.

Nozzle An adapter inserted in the intake manifold that receives the fuel transfer hose. The fuel system manufacturer should specify the location of the nozzle to comply with emission certification requirements. See Fuel Transfer Hose; Spud.

OEM Original Equipment Manufacturer. May refer to the manufacturer of a vehicle, a fuel system or an individual fuel-system component.

Ohms A measure of resistance in an electrical circuit, indicated by the Greek letter omega (Ω).

Piping Any part of a fuel system that conveys fuel from the tank to the engine. Piping is typically rigid or semi-rigid metal, but may be fabricated from other materials. See Tubing.

Propane One of the four regulated liquefied petroleum gases: propane, propylene, normal butane and iso-butane. The term "propane" is often used to refer to a mixture of LP gases that is predominantly propane.

Pulse Width

The amount of "on time" that a fuel injector is active in response to a command received from the vehicle's computer. Pulse width is measured in milliseconds. The longer the pulse width, the more fuel is metered to the cylinders. The pulse width of an engine running on propane autogas is typically about 10 percent longer than that of an engine running on gasoline.

Purging Removing any air, moisture or vaporized contents from a container. Purging may be accomplished by either pressure or vacuum, depending on the contents of the container. A container that has ever contained propane or another combustible product must never be vacuum purged.

SAE SAE International, formerly Society of Automotive Engineers. A professional engineering organization that develops and publishes standards for the automotive and aerospace industries.

SAE J1939

The SAE computer protocol for the diagnostic connector link (DCL) that transmits diagnostic information and other data to and from vehicle components. All vehicles made or sold in the United States since 1996 use the SAE J1939 standard. See ALDL.

Safety Box

The area under the hood generally considered to be the safest part of a vehicle. The safety box is bounded by the inside of the front fenders, the bulkhead or firewall, and the radiator core support.

Saturation Pressure

The minimum pressure required at a given temperature to keep propane in the liquid phase. If the pressure is reduced or the temperature increases, propane will vaporize and seek to return to its saturation pressure. If the pressure is increased or the temperature decreases, propane will remain a liquid. See Vapor Pressure.

Solder

A metallic alloy, typically tin and lead in varying proportions, used to join metal objects at temperatures (typically 360°F) high enough to melt the solder, but lower than the melting point of the workpieces.

Spud

Another term for the injector nozzle. See Nozzle.

STFT/LTFT

Short Term Fuel Trim / Long Term Fuel Trim. Fuel trim refers to the continual adjustment of an engine's air-fuel ratio by the vehicle's powertrain control module. STFT refers to adjustments made in response to temporary conditions. LTFT refers to longer-term adjustments. Trim values are used during diagnostics to determine how the vehicle has been performing or to program the auxiliary PCM.

Fuel trim values are expressed in percentages. Positive fuel trim values indicate adjustments for a lean mixture (added fuel). Negative fuel trim values indicate adjustments for a rich mixture (subtracted fuel). LTFT values generally should not exceed ± 10 -25 percent, or the vehicle's computer may set a fault code.

Stoichiometry

SAE standard J1829 defines "stoichiometric air-fuel ratio" as "the mass of air required to burn a unit mass of fuel with no excess of oxygen or fuel left over." An engine running at AF=1 or at Lambda (λ)=1 is operating at stoichiometry. See Air-Fuel Ratio; Lambda.

Submersible Fuel Pump

A fuel pump located inside a fuel tank and designed to be fully submerged in propane liquid. Submerging the fuel pump keeps it cool and lubricated during operation.

Tank A propane fuel container designed, tested, marked and fabricated in accordance with American Society of Mechanical Engineers (ASME) standards.

TPS Throttle Position Sensor, the sensor that measures the position of the throttle or the driver's requested throttle position. The output is measured in volts.

Transducer

A device that converts temperature or pressure information to an electrical signal and transmits the signal to the vehicle's computer.

TSB Technical Service Bulletin. A bulletin issued by a vehicle or fuel-system manufacturer indicating an updated repair or installation procedure. Autogas conversion technicians should be provided with a copy of all updated TSBs.

Tubing A part of the fuel system that conveys fuel from the tank to the engine compartment. See Piping.

Vapor Pressure

The pressure exerted by a propane vapor in equilibrium with propane liquid inside a closed container. See Saturation Pressure.

Vaporizer

The most common term for the device in a propane autogas fuel system that converts liquid fuel to vapor. See Converter.

VMV Vapor Management Valve. Also called a canister purge valve or evaporative emissions purge solenoid. On some Roush CleanTech systems, the fuel-rail pressure control module is a repurposed VMV that depressurizes the propane fuel rail into the vehicle's OEM charcoal canister to prevent the fuel injectors from leaking and ease hot restarts.

Volts Units that measure the electrical potential between two points in a circuit.

VPMI Vaporized Propane Fuel Injection. A technology in which propane vapor exiting the vaporizer is metered to the engine through individual fuel injectors, transfer hoses and nozzles.

Watts Units that measure the rate at which power is supplied or consumed in an electrical circuit.

APPENDIX D: CALCULATING ELECTRICAL LOADS

Autogas technicians use two physical principles, Ohm's Law and Watt's Law, to calculate loads in electrical circuits. For example, an installer may need to know:

- A fuel system's power requirements when configuring wire harnesses or calculating fuse loads.
- The original fuel injector electrical load when programming an auxiliary PCM.
- The resistance or voltage drop in a wire circuit when extending a run of wire.
- When there is excessive resistance between a body ground and the chassis.

Ohm's Law shows how current, voltage and resistance are related. Current is measured in amperes, usually shortened to amps. Electrical potential is measured in volts. Electrical resistance is measured in ohms.

Watt's Law shows how current, voltage and resistance are related to power produced or consumed.

- **Amps** is a measure of the rate of flow of electricity through a circuit, analogous to the rate of flow of water through a hose. Just as the rate of flow of the water depends on the size of the hose and the water pressure, the rate of flow of electricity through a wire depends on the size of the wire and the electrical force (potential, voltage) pushing it along. The symbol for amps is the capital letter I.
- **Volts** is a measure of electrical potential or force, analogous to the mechanical force or pressure pushing water through a hose. The symbol for volts is the capital letter V.
- **Ohms** is a measure of the resistance to the flow of electricity in a circuit, analogous to the resistance to water flowing in a hose due to friction, a reducer valve or a kink. All electrical circuits have some resistance. The symbol for ohms is the Greek capital letter omega (Ω).
- **Watts** is a measure of power, defined as the rate at which work is done. The symbol for watts is the capital letter W.
- Electrical power measured in watts (or kilowatts, equal to 1,000 watts) can be translated directly into units of mechanical power such as horsepower. $1 \text{ kW} = 1.34 \text{ hp}$.

The formulas for calculating these values are as follows:

Volts = amps x ohms or watts / amps

Amps = volts / ohms or watts / volts

Ohms = volts / amps

Watts = amps x volts

Example 1. Calculating the amperage a circuit will draw.

If a circuit's voltage and resistance are known, the amperage can be calculated by dividing the voltage by the resistance of the component in ohms. This value can be used to determine the proper rating for a fuse installed in the circuit.

For example, if a vehicle circuit operates at 14 volts—typical for a modern car while the engine is running—and the fuel lockoff solenoid is rated at 20 ohms, then the circuit for that component will draw 0.7 amps (14 volts / 20 ohms = 0.7 amps).

If more components are added to this circuit, such as a second lockoff rated at 20 ohms and an indicator light rated at 4 ohms, then the circuit will draw about 0.32 amps (14 volts / 20 ohms + 20 ohms + 4 ohms = $14V/44\Omega = 0.318$ amps).

Adding resistance decreased the amount of current flowing through the circuit and lowered the voltage across each component. When components are wired in series, the voltage to each component is decreased. When components are wired in parallel, the voltage stays the same.

Example 2. Calculating total resistance in a circuit.

If a circuit's voltage and amperage are known, the resistance in ohms can be calculated by dividing the voltage by the amperage. This value can be used to determine the proper gauge of wire to use when extending a run.

For example, if the voltage drops from 14V to 9V in a 10-amp circuit when a 6-foot run of wire from a PCM to an electric fuel lockoff located in the engine compartment is extended to a 24-foot run to a lockoff located at the rear of a full-size school bus, the circuit's resistance may increase by 0.5 ohms ($14V - 9V = 5$ volts drop / 10 amps = 0.5 ohms). In such a case, a heavier gauge of wire that offers less electrical resistance may need to be installed.

NOTE: Most ECU or PCM microprocessor systems use 5 volts for sensor reference, including the MAP, ECT, TPS, MAF sensors, and 12-14 volts for actuator outputs, including solenoids, fuel injectors, and relays. The technician should use a digital volt meter (DVM) to identify the source reference voltage (5V or 12-14V) for the components being measured.



Copyright © 2012 Propane Education & Research Council



Propane Education & Research Council
1140 Connecticut Avenue, N.W. Ste. 1075
Washington, D.C. 20036
(202) 452-8975

PRC 003605